

THE KANSAS SADDLE HORSE ASSOCIATION

RULEBOOK

Last updated: 02/01/23

LIST OF CLASSES WITH NO DESCRIPTION

CONSTITUTION	3
BY-LAWS	4
CONDUCT OF SHOWS.....	6
JUDGES	10
PROTESTS	11
PENALTIES	11
ANNUAL AWARDS	11
SHOW CLASSIFICATION	12
FACILITY STANDARDS	12
SPECIAL ANNUAL AWARDS	13
MEMBERSHIP	14
APPROVED CLASSES AND DESCRIPTIONS	14
REGISTERED AMERICAN SADDLEBRED	14
REGISTERED APPALOOSA AND POA HORSES	16
REGISTERED ARABIAN & HALF-ARABIAN HORSES.....	16
DISCIPLINED RAIL.....	17
ENGLISH PLEASURE	17
EQUITATION DIVISION.....	17
FOX TROTTERS	18
HUNTER	19
LEADLINE.....	20
REGISTERED MINIATURE HORSES	20
REGISTERED MORGAN HORSES.....	20
REGISTERED PAINT/PINTO HORSES.....	21
REGISTERED PALOMINO/BUCKSKIN/DUN HORSES	21
PASO FINO HORSES	21
PLEASURE DRIVING, OPEN	22
PONY DIVISION	22
REGISTERED QUARTER HORSES	22
REINING.....	22
ROADSTER	23
SIDESADDLE.....	23
SHOWMANSHIP AT HALTER	23
REGISTERED TENNESSEE WALKING HORSES	24
TRAIL HORSE.....	25
VERSATILITY	26

WESTERN PLEASURE.....	26
NON-BREED SPECIFIC HALTER (FOR NON-REGISTERED OR KSHA UNREPRESENTED BREEDS).....	27
REGISTERED FRIESIAN IN-HAND.....	27
SUPER HORSE.....	27
WESTERN RIDING.....	27
WALK WHOA 18 AND UNDER OR CHALLENGED RIDER (WESTERN OR ENGLISH).....	29
RANCH RIDING.....	29
OBSTACLE DRIVING.....	30
BABY HALTER 2 AND UNDER.....	31
LONG LINE YEARLING AND 2 YEAR OLD.....	31
PARADE HORSE/PONY OPEN.....	31
RANCH RAIL PLEASURE.....	32
LIST OF CLASSES WITH NO DESCRIPTION.....	32
REINING PATTERNS.....	35
BEGINNER'S EQUITATION PATTERNS.....	38
RANCH RIDING PATTERNS.....	42

CONSTITUTION AND BY-LAWS
The Kansas Saddle Horse Association, Inc.

CONSTITUTION

Article I NAME

The name of this Association shall be THE KANSAS SADDLE HORSE ASSOCIATION, INCORPORATED.

Article II OBJECTS

1. To promote the education of the people of Kansas in breeding, care, use, handling, and development of horses and horsemanship.
2. To encourage good sportsmanship and proper conduct among horsemen and horsewomen and to foster good fellowship among all persons interested in Saddle Horses.
3. To encourage proper and humane handling and care of horses and to prevent cruelty to animals.
4. To assist in establishing a horseshow circuit in the state of Kansas.
5. This Association shall be a non-profit organization and shall not be conducted for pecuniary profit, and there shall be no capital stock.

Article III MEMBERS

Any person who shall be recommended by a member of the Association shall be entitled to a membership in this Association upon the payment of a membership fee as fixed by the Association, unless said application for membership shall be rejected by the negative vote of a majority of the Board of Directors. Any individual, firm, partnership, Association, or corporation, doing business in the state of Kansas, who shall be recommended by a member of this Association, shall be entitled to a corporate or sustaining membership in this Association upon compliance with such conditions and the payment of such fees as may be determined by the Board of Directors, unless said applicant for membership shall be rejected by the negative vote or a majority of the Board of Directors. Any individual who is eligible for membership in this Association may purchase more than one membership, but shall be entitled to only one vote at any regular or special meeting of this Association.

Article IV OFFICERS AND DIRECTORS

The officers of the Kansas Saddle Horse Association shall be a President, a 1st Vice President, a 2nd Vice President, a Secretary, and a Treasurer who shall be selected from the Board of Directors of said Association and voted upon by the membership. The Board of Directors shall consist of not less than three nor more than twenty one members. The Board of Directors shall be elected in the following manner: At the first annual meeting, one third of the directors shall be elected for one year, one third for two years, and one third for three years. At each succeeding annual election, the vacancies occurring shall be filled by electing directors for periods of three years, and the term of Directors so elected shall commence on the first day of the month following their election. NO member shall hold more than one office at a time or be eligible to serve more than two consecutive terms in the same office, except at the pleasure of the Board of Directors.

The duly elected President and Vice President of the Junior Kansas Saddle Horse Association shall be voting members of the Board of Directors of the Kansas Saddle Horse Association and shall be in addition to the number of Directors provided above.

When voting for the board members, the next two highest voted members after the board is selected who were not selected for the board will be alternates on the board for 1 year unless they replace a vacancy on the board then they will finish out the term of the board member they are replacing. Those individuals elected as Alternates to the Board of Directors do not have voting privileges until they become active members of the Board of Directors, but are encouraged to attend meetings in order to stay current on the business being conducted on the Associations behalf.

Article V MEETINGS

All meetings of the members of this Association shall be held annually at such time and place as shall be designated by the Board of Directors of this Association.

Article VI AMMENDMENTS TO THE CONSTITUTION

The Constitution of the Association may be amended at any regular or special membership meeting by a two-thirds vote of the members present, provided that the proposed amendment shall have been read at one previous meeting or provided copies of the amendment shall have been sent to the members with the notices of said meeting.

BY-LAWS

Article I DUES

The dues of each member or saddle club shall be set annually at the general membership meeting. Each member whose dues are fully paid, and who is in good standing shall be entitled to one vote at any regular or special meeting of the members of the Association. Family memberships get two (2) votes per membership, and two family members must be present to utilize the two votes. Such votes shall be cast in person, provided however, that votes may be cast by mail and/or other board approved method when a copy of the question, motion, or resolution is attached to such votes. A member shall cease to be a member when his or her dues become delinquent.

Member show fees shall be set annually at the general membership meeting. A show thus becoming a member of the Association shall be bound and governed by the Associations official horse show rules and shall be entitled to the benefits of the yearly horse show rating and the services of the rules committee in enforcing penalties.

Article II OFFICERS

PRESIDENT

The President shall be the chief executive officer of the Association; he shall preside at all meetings of members and directors; he shall have general and active management of the Association; he shall see that all orders and resolutions of the Board of Directors are carried into effect, subject to the right of the directors to delegate any specific power, except such as may be by statute exclusively conferred upon the President to any officer or officers of the Association; he shall execute or cause to be executed all contracts of the Association. He shall appoint any and all committees which in his discretion are necessary or proper and shall be an ex-officio member of all said committees; he shall have the general powers of supervision and management usually vested in the office of the President.

VICE PRESIDENTS

In the absence of the President, or in case of disability of the President, the 1st Vice President shall perform the functions of the office of the President and shall further be in responsible charge of the annual KSHA Horse Show. A 2nd Vice President shall serve in the absence of the 1st Vice President, and be in responsible charge of the annual awards convention. The KSHA Board of Directors will advise the 2nd Vice President concerning matters of budget and awards.

SECRETARY

The secretary shall attend all sessions of the Board of Directors and all sessions of the members and act as the clerk thereof, and record all votes and the minutes of all proceedings in a book to be kept for that purpose and shall perform like duties for the standing committees when required. He shall give or cause to be given notice of all meetings of the members and the Board of Directors when required to do so by the President, and shall perform other such duties as shall be prescribed by the Board of Directors or President. He shall be an ex-officio member of all committees.

TREASURER

The treasurer shall keep full and accurate accounts of receipts and disbursements in books belonging to the Association, and shall deposit all moneys and other valuable effects in the name and to the credit of the Association, in such depositories as may be designated by the Board of Directors. He shall disburse the funds of the Association as ordered by the Board of Directors or on order of the executive committee, taking proper vouchers for such disbursements, and shall render to the President and directors at the regular meeting of the board or whenever they may require it, an account of all his transactions as treasurer and of the financial condition of the Association. He shall, if requested or required, give the Association a bond to be paid for by the Association in such sum and with sureties as may be satisfactory to the board for the faithful performance of the duties of his office and the restoration of the Association in case of his death, resignation, or removal from office, all books papers, vouchers, money, and

other property of whatever kind in his possession belonging to the Association. The treasurer shall prepare and file with the secretary not later than January 20, each year a full and complete financial statement covering the preceding year, the balance sheet and profit and loss statement of which shall be published in the next succeeding issue of the official organ of the Association or sent separately to each of the members. The office of secretary and treasurer may be held by the same person if the directors deem it advisable. At the end of each year, the board will vote on how much funds to protect to be able to start the next year with so that the banquet does not use more funds than we can afford to keep the club running. Currently, that amount has been around \$5000.

Article III BOARD OF DIRECTORS

The board of directors shall consist of not less than three nor more than twenty one members to be chosen from the various communities of the state to the end that the board may be representative of the state as a whole. The business, activities, and property of this Association shall be managed and controlled by the board of directors who shall meet at least once each year and as often as may be deemed necessary. Special meetings of the board of directors may be called at any time and place by the president, and shall be called by the president at any time upon the written request of a majority of the board of directors. Only members in good standing as is reflected by the books of the treasurer of the Association shall be eligible for membership on the board of directors.

The duly elected president and vice president of the Junior Kansas Saddle Horse Association shall be voting members of the Board of Directors.

Article IV EXECUTIVE COMMITTEE

The Executive Committee shall consist of the elected KSHA President, 1st Vice President, 2nd Vice President, Treasurer and Secretary and will include 2 at-large members in good standing selected by the President and approved by the Board of Directors. The executive committee shall, in the absence of specific directions from the board of directors, have the sole power to authorize the execution of any contract on behalf of the Association or the expenditure of any of its funds. Any delegation of power to the executive committee by the directors shall not operate to relieve said board of directors or any member thereof, of any responsibility imposed upon it or him. Meetings may be called by the president or by the request of a majority of the members of this committee. No member shall hold more than one office at a time or be eligible to serve more than two consecutive terms, except at the pleasure of the board.

Article V ELECTIONS

The election of directors shall be held by mail ballot and/or other board approved communication sent to each member at least thirty days prior to the annual meeting. A nominating committee of not less than five nor more than nine members shall be appointed by the president. It shall be the duty of said nominating committee to confer with members from throughout the state and to nominate at least two members as candidates to replace each director whose term expires at the time of the annual meeting.

It shall be the further duty of the nominating committee to cause a ballot with the names of the nominees so selected, to be sent to each member at least thirty days prior to the annual meeting. It shall be the privilege and duty of each member to properly mark his or her ballot and submit to the secretary of the Association or other person designated by the president, in order to reach the person so named by the date stated on the ballot at which time the polls shall be closed. Any member may write in names of candidates other than those selected by the nominating committee. The president shall appoint a committee of judges of elections (none of whom shall have been members of the nominating committee), whose duty it shall be to count the ballots and announce the results of the election to the members during the annual meeting.

Other rules pertaining to the marking of ballots and casting of votes according to usual practice shall accompany each ballot. Only members whose dues have been paid at the time the polls are closed will be entitled to vote.

Article VI MEETINGS

ANNUAL MEETING

There shall be an annual meeting of the members of the Association in each calendar year, on such day and time as may be fixed by the board of directors and said board of directors shall cause notice to be given of such meeting by mail and/or other board approved communication to each member of the Association in good standing, at least ten

days before the date and time fixed for such meeting by the board of directors.

SPECIAL MEETINGS OF MEMBERS

Special meetings of members may be called by the president, by the board of directors, or by not less than twenty-five percent of the members of the Association who are not delinquent in their membership dues.

1. "Quorum". The members of the Association present at the annual meeting shall constitute a Quorum.
2. Three or more members of the board of directors shall constitute a Quorum for the transaction of any business and the act of the majority of the directors present at the meeting at which a quorum is present shall be the act of the board of directors unless the act of a greater number is required by law or by the by-laws. The board of directors shall be sent a notice of meeting at least five days previous to such meeting.
3. The majority of the Executive Committee shall constitute a quorum for the transaction of business. Seven days previous notice of meetings shall be sent to members of this committee, with a follow-up confirmation via personal contact (email with immediate response or telephone).

Article VII ELECTION OF OFFICERS

Officers of the Association shall be elected by a vote of the membership. The annual meeting of the election of officers shall be held within thirty days of the time of the annual election of directors by the members.

Article VIII VACANCIES

1. If the office of any director or officer of the Association becomes vacant by reason of death, resignation, disqualification or otherwise, the remaining directors shall elect a successor who shall hold office during the unexpired term of his predecessor and until this successor is elected and qualified.
2. Any director or other officer may resign his office at any time, such resignation to be made in writing, and to take effect from the time of its receipt by the Association, unless some time be fixed in the resignation, and then from that date. The acceptance of a resignation shall not be required to make it effective.
3. Any officer may be removed at any time for any reason upon the vote of two-thirds of the entire membership of the board of directors.
4. The office of any director who fails to attend three consecutive meetings of the board shall be declared vacant and a successor elected by the board to fill the unexpired term.

Article IX LIABILITIES

The Association shall not have the power to subject itself to an indebtedness exceeding the current funds at the time in the treasury and the members of this Association shall not be liable for any debts of the said Association.

Article X COMPENSATION OF DIRECTORS

Directors of such, shall not receive any salary for their services but by resolution of the board may be reimbursed for any actual necessary expenses incurred by reason of their directorship.

Article XI AMENDMENTS TO BY-LAWS

The by-laws of this Association may be adopted or amended at any regular or special membership meeting by a two-thirds vote of the members present, provided the proposed amendment shall have been read at one previous meeting or provided copies of the amendment have been sent to the members with the notice of said meeting.

By-Laws of this Association may also be amended by mail and/or other board approved communication, providing ballots are sent to all members setting forth in detail the proposed amendments and allowing members twenty days in which to cast their ballots. Two-thirds of the votes so cast must be in affirmative to authorize such amendments.

CONDUCT OF SHOWS

1. To hold a Member show, application shall be sent to the Show Chairperson of the Kansas Saddle Horse Association (KSHA). Show dates must be approved by the Show Chairperson. **PROOF OF INSURANCE** must be included with the application. A copy of the Proof of Insurance will be submitted with the show application form prior to the show being scheduled and actively promoted by KSHA.

2. A preliminary showbill should be sent to the KSHA Show Chairperson at least seven (7) weeks prior to the show. Upon approval, the showbill will be returned to the Show Secretary for printing. Showbills must be provided to all KSHA members three weeks prior to the show or earlier via U.S.P.S. or e-mail.
3. Any shows adding classes after the showbill is provided to the members must notify all KSHA members via U.S.P.S or e-mail 10 days or more prior to the show. **CLASSES ADDED AT THE SHOW WILL NOT QUALIFY FOR KSHA YEAR END POINTS.**
4. The member shows shall furnish the KSHA Show Chairperson a record of the judge's placings for each class as well as all the class entries. This record should give the owners' names, horse's name and exhibitor's name, and should be received within 30 days from the date of the show. Failure to comply with this rule could result in the omission of the show results from the tabulation for Annual Awards.
5. Each Show will provide a qualified judge. (see Judges)
6. Every Member show shall appoint a Ring Committee which shall be responsible for the enforcement of the Rules. They shall operate under the authority of the KSHA Rules and Regulations. Controversial matters shall be referred to the KSHA Rules Committee whose decision shall be final.
7. Every Member show must have a competent and duly instructed Ringmaster whose duties shall be to assist the Judge by giving commands and maintaining order and safety in the ring during the showing of all classes. A Paddock Judge or Steward is recommended to check exhibitors' attire and tack prior to the class. Neither the Paddock Judge nor the Ringmaster will influence the decision of the Judge.
8. Every Member show shall furnish an announcer, concessions, clean restrooms with adequate facilities close enough for exhibitors to use between classes, and a working spigot with fresh running water placed in a position where water can be easily accessed. It is recommended to have phone numbers for veterinarian, farrier and emergency services at the office. Parking facilities should be adequate to accommodate large trailers and have solid enough footing that the vehicles do not become stuck. Every member show shall meet the qualifications of Facility Standards noted in this book.
9. If equipment is available, it is recommended the Show Committee be prepared to water down a dry ring for dust control or take adequate action to dry a wet muddy ring. In either case, suitable footing for all types of horses must be provided.
10. If the classes include those for Saddlebred horses, then stall facilities are recommended.
11. Each Member show must provide on its entry blank a space for the designation of the registration number, height, and sex of each entry. It shall be the duty of each exhibitor to give the correct height of each horse or pony measured in the shoes which will be worn at the time of showing. Recommended standard entry forms may be obtained from KSHA.
12. Judges evaluation forms are available on the KSHA website.

GENERAL RULES

1. A period of not more than 3 minutes may be allowed to enter the ring. A maximum of 5 (five) minutes will be allowed for tack changes with prearranged notification to the gate person/paddock master (and announcer, if attainable). At the expiration of this period, the gates shall be closed and no other horses will be allowed to enter.
2. The judging of a class shall be suspended for a period not to exceed seven (7) minutes to allow repair to be made to equipment or the horse re-shod. A given horse may stop a second time for re-shoeing if there is time remaining of his original seven minutes. If not, he must continue barefoot or leave the ring.
3. **STALLIONS** are barred from all classes restricted to Ladies in the American Saddlebred and Morgan divisions. Youth are prohibited from showing Stallions, except youth age 13 & over may show Miniature stallions in

classes restricted to Miniature horses.

4. All horses shall be serviceably sound for the intended purpose.
5. Silver mounted equipment may be used in western classes but this equipment shall not count over a good working outfit.
6. Headers are required for all youth in driving classes. Headers (for other than youth) are optional in all driving classes.
7. Australian type saddles are permitted provided that they have a horn.
8. In any class, all entries must be on the same basis. It shall not be permissible for a show to accord free entries, transportation, or other expenses to any individual exhibitor.
9. In performance classes, there shall be no substitution of riders or drivers after the class has started.
10. An amateur, for horse show purposes, is one who rides or drives for the love of the sport, not as a professional for a livelihood, and who does not receive monetary payment for his/her services. All Beginners and KSHA Adult Approved classes are for amateurs only. Amateur is considered an adult 19 and over or per breed association rules.
11. Exhibitors' numbers are to be worn on the exhibitors' backs. In Hunt Seat and Western Under Saddle Classes, the number is suggested to be attached to each side of the horse. In driving, the number may be displayed on the back, on each side of the cart or on the exhibitors back.
12. Sidesaddles are prohibited in any class other than Ladies Sidesaddle and in Leadline.
13. A KSHA member shall not be required to have a USEF Amateur Card except at USEF Member shows. A professional may enter any class unless it is restricted to amateur exhibitors.
14. NON-REGISTERED HORSES--All classes not limited to a specific breed are open to both registered and non-registered horses.
15. All Classes with a Pattern or Course must have the pattern or courses posted at least one hour prior to the first class of the session for that class. Show management may post patterns prior to the show on the KSHA Facebook page, KSHA Website or by email to current members. Patterns must be visible at all times once they are posted.
16. All of the available arena shall be utilized in performance classes, unless physically impossible.
17. For the safety of exhibitors, other entries or spectators, any horse deemed unruly, unsafe or unsound may be excused or removed from the ring by the judge or show management. KSHA discourages the use of a stallion in KSHA Approved Adult Walk/Trot Classes.
18. Any conduct, inside or outside the arena, (such as, but not limited to yelling, coaching, towels, whips, bags, etc.) which disturbs or interferes with other exhibitors is prohibited. Incidents or accidents that occur outside the arena shall be addressed by the show management. This is not the responsibility of KSHA.
- 19.. References to Hackamore mean a rawhide braided, leather braided, or rope bosal. Mechanical hackamores are prohibited.
20. References to a Snaffle Bit in Western classes mean the use of a smooth snaffle bit with a broken mouthpiece (conventional "O" ring, egg-butt, or "D" ring) and rings no larger than 4".
21. Bosals and ring snaffles with 2-4" rings may be used on any horse of any breed five (5) years and under in

any Western Pleasure class.

22. References to Standard Western Bit mean the use of a curb bit that has a solid or broken mouthpiece, has shanks and acts with curb action from a curb strap or chain.

23. Any solid iron under the jaws, regardless of how padded or covered, is prohibited. No curb chain or strap less than ½ inch in width. Junior horses 5 years and younger shown western may be shown in a curb, snaffle bit or a non-mechanical hackamore/bosal or equipped based on breed association rules. Senior horses 6 years and over shown western must be shown in a curb bit with a curb strap or equipped based on breed association rules. This would allow breeds that normally are ridden two handed to be allowed to do so.

24. All horses shall be shod in accordance with the latest revisions of USDA regulations and/or individual breed requirements. Any artificial appliances other than those permitted in division rules are prohibited, except at the discretion of show management, which will be announced.

25. The Kansas Saddle Horse Association shall be recognized as an Equine Association. Mules and Donkeys allowed.

26. Rule Change Requests must be submitted via e-mail, postal service or in person to the KSHA President prior to November 1st. These proposals will be forwarded to the Forman of the KSHA Rules Forum who will present them to the KSHA Rules Forum following receipt of request. The KSHA Rules Forum will make recommendations including precise wording and rule book location to the Board of Directors (BOD). Upon approval by the BOD these change requests will be brought to the general membership at the annual General Meeting for a vote. Proposed rule changes will be presented to the membership in writing three weeks prior to being voted on. If the BOD does not recommend a proposed rule change it will return to the KSHA rules Forum. Rule proposals can only be submitted by current KSHA members.

27. A safety helmet is permitted in any class.

28. It is the tradition of the show ring that riders and drivers be correctly attired for the class in question, that attendants be neatly dressed and horses be properly presented. Attire is based on traditional and general present-day customs consistent with breed standards. Judges, at their discretion, may authorize adjustments to attire due to weather related conditions. Regulation safety headgear of any style may be worn in any class, for example, a hunt-style cap may be worn in a western class.

Saddle Seat Attire

Informal: Conservative colors in herringbone, pin stripes and other combinations of colors that appear to be solid. Solid colors include black, blue, grey, dark burgundy, dark green, beige or brown jacket with matching jodhpur, derby hat, gloves, and jodhpur boots. Day coats in contrast to darker jodhpur are permitted in pleasure classes. Gaudy colors should be avoided. Only informal dress is permitted in Pleasure Equitation classes, day or night.

Formal: Even more conservative attire and accessories are required for evening equitation, park, and 3-gaited performance classes. Solid colors include dark grey, dark brown, dark blue or black tuxedo-type jacket with collars and lapels of the same color, top hat, and jodhpurs to match and gloves or dark-colored riding habit, accessories and jodhpur boots. Formal jackets in contrast to darker jodhpur are permitted in park and 3-gaited performance classes. Gaudy colors should be avoided. Formal riding habits are not to be worn before 6:00 p.m. and are not mandatory after 6:00 p.m.; exhibitors competing on Pleasure horses have the option to wear formal attire in Open equitation classes as specified by the rule.

Misc.: Spurs of the unrowelled type, whips or crops are optional.

Western Attire

Riders must wear Western hat or regulation safety headgear, long-sleeved shirt with collar, trousers or pants and boots. Chaps, ties, gloves and spurs are optional. A vest, jacket, coat, and/or sweater are optional.

Hunt Seat Attire

Attire shall be traditional hunter-style coats of any tweed or melton for hunting (conservative wash jackets in season), breeches or hunter jodhpurs, dark hunting cap, derby or protective headgear and appropriate boots. A stock choker or four in hand with any color shirt is correct. Shad bellies are prohibited except in Show hack and Sidesaddle. When management permits Hunter or Hunter Seat Equitation riders to ride without jackets, riders must

wear traditional, short or long-sleeved riding shirts with chokers or ties. Polo shirts are not permitted except in un-judged warm-up classes.

Regulation Safety Headgear:

Riders in all classes where jumping is required and when jumping anywhere on the show grounds must wear regulation safety headgear (Exception: Trail classes). Headgear harness must be secured and properly fitted.

Miscellaneous: In all classes, gloves, hunter crop or bat, and spurs are optional.

29. KSHA Requires show management to split rail work classes with 16 or more entrants in any KSHA point class specifically for junior riders, junior horses or beginning riders. (Example: Saddleseat Pleasure 18 and under, Beginning Walk/Trot Hunt Seat Pleasure 19 & Over, Western Pleasure Junior Horse). Non-KSHA point classes will be conducted at show management's discretion. When a rail work class is split, a final run-off class is required, consisting of not more than six horses from each split. All splits and the final run-off class must run consecutively to each other. Awards should only be given in the final run-off class, and not in the individual splits.

30. No more than eight horses shall be allowed to show at a Hand Gallop at one time.

31. For KSHA, youth shall be defined as 18 and under for classes and year end awards, and for USEF youth shall be defined as 17 and under. USEF includes Saddlebreds, Arabians, and Half-Arabians.

32. All adults riding in the 19 and over or Adult Approved Walk/Trot classes must be KSHA members, be classified as an amateur and have a KSHA Approved Adult application on file. To obtain the approval an individual must fill out the official application, available on the Web site, and submit it to the KSHA Board of Directors for approval. The individual will be able to show in Adult Approved classes while approval is pending by the Board, but not until the form has been submitted. Exceptions to the walk/trot rule may be obtained from the KSHA Board of Directors in writing prior to the show. KSHA Adult Approved classes are for amateurs only.

33. Any class may be split to count for points as long as all divisions are included. Examples include but are not limited to: age of horse or rider, sex of horse or rider, type of seat.

34. When no specific KSHA rule applies, use relevant breed association rules. If this creates a conflict, refer to the rules committee.

JUDGES

1. The horse show Judge will have complete knowledge of the Rules of the classes to be judged. To the best of his/her ability, the Judge will give an unbiased decision according to the rules of the class. No contact may be made with the Judge without the approval of the Show Committee and only after the exhibitor has completed showing. No Judge shall be influenced by comments from the Ringmaster or Announcer.

2. The Judge's name will be listed on the showbill. A current list of prospective Judges is available from the KSHA Show Chairperson.

3. No horse may be shown before a Judge that has been sold by said Judge or by his employees within a period of six (6) months prior to the show.

4. No exhibitor may show before a Judge who boards, rides, or trains (for horse show purposes) any horse under said exhibitor's ownership or lease within a period of six (6) months prior to the show.

5. A judge may not operate in any capacity other than judging at a show.

6. A Judge may work no more than two KSHA member shows per year and said two shows are not to be consecutive.

PROTESTS

1. Any exhibitor lodging a protest must first deposit with the Horse Show Secretary, a check in the amount of \$50.00 made payable to KSHA. All protests must be in writing, signed by the protester, and must be lodged with the Show Secretary within 48 hours after the award is made. All protests must be immediately referred to the KSHA Rules Committee whose decision shall be final. If the protest is sustained, the entries standing next in award will be moved up. If the protest is not sustained, the fee will be forfeited.
2. The Kansas Saddle Horse Association will bear all expenses pertaining to the protest up to the amount of the protest fee. Expenses over and above this amount shall be borne equally by the member show and KSHA.

PENALTIES

1. Any act of discourtesy or disobedience to a Judge, or to an official of this Association, or of a member show, by an owner, exhibitor, or his agent, employee, rider, driver, stable manager or groom, or by a parent or husband or wife or other close relative of such competitor, shall be deemed to constitute conduct prejudicial to the best interest of this Association. Upon request of the KSHA Rules Committee by the Secretary or any member of the horse show committee, the KSHA Rules Committee shall have the power to debar from showing at any member show, any or all horses or persons from the stable concerned, for such a period of time as they may determine the offense warrants. The KSHA Rules Committee will immediately notify all members of any such action.
2. If a member fails to settle his or her account at one of our member shows, and if the show so notifies KSHA in writing, KSHA will write a certified letter to that member informing him or her that points earned at that show will not be counted toward year end awards, nor will any points earned at subsequent shows during that same year be counted until either the show management notifies KSHA that the account has been settled, or until the KSHA board of directors rules the account settled.

ANNUAL AWARDS

1. Awards will be presented to the nominator of the horses in performance classes, and the riders in equitation classes, earning the six (6) highest positions in each division and subdivision listed in the current rules of approved classes, subject to having placed in three (3) or more of the accredited classes held during the calendar year in member shows. The Board of Directors must approve all classes prior to the start of the season.
2. KSHA will use every care to achieve accuracy in computing the show classification and tabulating the placings, but not be liable for the failure of any member show to file the results of their show nor for errors or omissions in their making thereof, nor responsible beyond the point of accuracy in computing the final ratings from the results submitted by the proper authorities of each show.
3. The cumulative score earned by an entry within the respective classification shall be included in the reckoning of the final placing regardless of transfer of ownership within the period of competition. The owner/lessee of the horse at the time of scoring its last point shall be the recipient of the award.
4. The entry scoring the highest number of points in its classification at Member shows held throughout the calendar year shall be considered the winner; the entry scoring the next highest number of points shall be awarded the second place; and so on until six places have been determined. In the case of a tie, two same-place ribbons will be awarded, for example, 1st, 2nd, 2nd, 4th, 5th, and 6th. Duplicate awards will be given in case of ties for first place.
5. In figuring the final placings for annual awards, points for classes with approved splits and/or championship or stake classes, will count toward the approved class. In cases of Western pleasure Open, English Pleasure Open and Hunt Seat Pleasure Open Championships, it shall be the option of the exhibitor/participant to notify the KSHA Show Chairperson in writing within 10 days of the show as to which class the points should be credited. For the points to count, the exhibitor must have shown in a qualifying class. In the event of an approved split when a horse and/or rider enters multiple divisions, the highest placing received toward an approved class will be the placing recorded for year-end award calculations.
6. In any and all cases not specifically covered by the rules and regulations, the right is reserved by the Recording Secretary to follow such procedures as will, in his/her best judgment and discretion, best serve the common interest of the exhibitors, the member shows and the Association. Such discretionary judgment shall be

approved by the KSHA Rules Committee.

7. Any question or dispute in connection with the computation of these awards shall be referred to the KSHA Rules Committee for decision. Its verdict shall be final.
8. A final record showing the tally and score of each entry participating at any Member show will be kept in the files of the Recording Secretary, and information in connection therewith will be available upon request for 60 days following the awards banquet.
9. Annual award points will be accumulated from the time of receipt of horse nomination and membership dues for the current years' shows.
10. Requests to donate new perpetual trophies are no longer being accepted (as of 2004). Perpetual trophies currently in circulation will be permanently retired at the discretion of the Board of Directors. Any new requests to sponsor a Special Annual Award shall be considered by the Board. Requests include a three (3) year commitment, and the award requirements shall include multiple classes or divisions.
11. KSHA encourages individual class sponsorship for any Annual Award. Class sponsors are responsible for reimbursement to KSHA for the cost of the annual award.

SHOW CLASSIFICATION

The Kansas Saddle Horse Association offers a yearly horse show rating system under the regulations set forth:

1. To qualify for an approved KSHA Show, the showbill must include 80% KSHA approved classes exclusive of stake and championship classes unless prior approval is given by the KSHA Show Chairperson. At least five (5) open classes must be included that allow entries of any breed including unregistered horses. Payback, ribbons and awards are optional. (EXCEPTION: Payback shall not be permitted in Equitation or Showmanship classes.) Alternate fee schedules at the discretion of show management.
2. It is recommended that at least 30% of the entry fees be paid back, to at least the top three (3) placings.
3. Points will be computed on the basis of: 1st place gets 6 points, 2nd place gets 5 points, 3rd place gets 4 points, 4th place gets 3 points, 5th place gets 2 points, 6th place gets 1 point. If classes are split, each division must be offered for any points to count.
4. Six (6) placings shall be awarded in each class.
5. The use of a set of uniform show rules and the services of the Rules Committee in enforcing penalties, any horse show, by payment of the Show Fee, may become a Member show of the Kansas Saddle Horse Association and then be governed by their rules. Show Management not complying with the rules shall be put on probation and/or have its show dropped from the list of KSHA approved shows.
6. Application and preliminary list of classes must be sent for approval at least seven (7) weeks prior to said show, in order to qualify as a member show. Final showbill must include the list of classes, location, date, time, and Judge's name, entry fee and payback. Show dates for KSHA will only be approved for the season of April 1st through October 31.
7. Show application fee of \$50 per set of judged points is due with show application. Waivers can be applied for.

FACILITY STANDARDS

Calling a Show: There must be three (3) members of the KSHA Rules Committee present in order to call (cancel) a show. If only one or two members are present, they may appoint KSHA members to temporarily fill those positions. If all three committee members agree that the facilities are (or have become) unsafe or inadequate (i.e. standing water in the show arena) they may cancel the KSHA recognition for that show. From that point, no classes held will

count for KSHA points. If the rules committee rules that the show arena is or has become unsuitable for horses, show management may move the show to an alternate location, or hold the show in the grass if it is approved by the rules committee as safe and adequate. **LOSS OF STATUS MUST BE ANNOUNCED, AND MUST BE DISPLAYED AT ENTRY TABLE.**

Facilities: The minimum size for any KSHA show area should be 60 feet by 110 feet, or a comparable area. The show arena must have safe and reasonably level footing that should not be more than four inches deep. Parking facilities should be adequate to accommodate large trailers and have solid enough footing that the vehicles do not become stuck.

SPECIAL ANNUAL AWARDS

A perpetual award is the property of KSHA and must be returned each year regardless of the number of times anyone wins the award.

Junior Exhibitor of the Year: English and Western Champion and Reserve Champion awards and ribbons to six (6) places will be presented to the Junior KSHA members who earn the most points in showmanship as well as riding classes that require a canter or lope and are restricted to exhibitors 18 years and under. Points are to be based on the current KSHA point system.

Cleo Ray Perpetual Trophy: For high point rider in American Saddlebred 3-Gaited Pleasure, English, Youth. Donated by the Walter Zitlow Family and maintained by the American Saddlebred Association of Kansas.

Mr. Nero Annual Award: Presented to the Beginners Walk-Trot only, 18 and under western rider accumulating the most points in Walk-Trot Western Pleasure and Beginners Walk-Trot Western Horsemanship classes. Donated by Sarah and Betty Robinson.

Battle Banner Perpetual Trophy: For the 5-gaited horse accumulating the most points. Donated in honor of Cleo Ray and maintained by the American Saddlebred Association of Kansas.

The Overall High Point Half-Arabian Horse Award: To be given to the Half-Arabian Horse that has accumulated the most overall points for the year in Half-Arabian classes. The award is sponsored by the Kansas Arabian Horse Society.

The Overall High Point Arabian Horse Award: To be given to the Arabian Horse that has accumulated the most overall points for the year in Arabian classes. The award is sponsored by the Kansas Arabian Horse Society.

Annual Unregistered Horse Award: For the unregistered horse receiving the most points. Donated by The Anvil.

Junior Perpetual Award For Sportsmanship: For the youth exhibiting the highest degree of all-around sportsmanship in and out of the ring. Award donated and presented by the Junior Association of KSHA.

Junior Walk/Trot Exhibitor of the Year: Champion and Reserve Champion awards to be presented to the Junior KSHA members who earn the most total points in walk/trot classes restricted to exhibitors 18 years and under and in showmanship classes.

Approved Adult Exhibitor of the Year: Classes that count for this award include Western/English Walk-Trot Equitation, Walk-Trot Western Pleasure, and Walk-Trot English Pleasure. Donated by Laura and Denise Meyer.

Commander's Power Play Award: Given to the American Saddlebred Country English (saddleseat) and Country Western horse with the most points, with points from both divisions to count. Donated by Katie Yaverski.

Betty Robinson Memorial Adult Sportsmanship Award: For the adult exhibiting the highest degree of all-around sportsmanship in and/or out of the ring. Award sponsored by Sarah Robinson.

Irene Zane Registered American Saddlebred Pleasure Perpetual Trophy: For the Registered American Saddlebred horse accumulating the most points in any one Registered ASB Pleasure class. Donated by friends of

Irene Zane and maintained by the American Saddlebred Association of Kansas.

Okies Jasmine Memorial Award: For the Registered Paint/Pinto horse who qualifies in all three Paint/Pinto classes and Trail or Hunter Hack. Award sponsored by Jasmine Pumphrey.

High Point Horse Award: For the horse that accumulates the most points in any one class in a single show season. Horses must be KSHA-nominated but may be shown by any exhibitor or exhibitors throughout the year. Award sponsored by Straight Path Farm.

The Harlene Howey Memorial Arabian/Half Arabian High Point Award: This award goes to the Arabian or Half Arabian Horse with the highest cumulative KSHA points. All Arabian, Half Arabian and open classes to count towards this award. This award is donated by the Kansas Arabian Horse Society as a paper certificate and a \$25.00 gift certificate.

MEMBERSHIP

1 Membership fees will be paid in full for the current year and show season by the first show of the season. Membership fees paid at any time during the current show season will be credited to the current year. Any Membership fees received after the last show of the season will be credited to the following year. Points will begin to accumulate upon receipt of membership and nomination fees.

2 Adult Membership-- It is required that the riders in equitation and Approved adult walk trot be a KSHA member in order to participate in the Annual Awards. Adult memberships shall have one vote each.

3 Junior Membership--it is required that riders in equitation classes be a KSHA member in order to participate in the Annual Awards. Junior memberships shall have one vote each.

4 It is required that the nominator of any horse participating in the Annual Awards, in performance division, must be a KSHA member.

5 Family Membership-- For immediate family members (not cousins or in-laws, etc.). All are eligible for awards in their respective age groups. Two (2) votes per membership, and two family members must be present to utilize the two votes.

6 Horse Nomination Fee--An annual fee of \$15.00 is required for all horses competing for Annual Awards. It is transferable to a new owner and points accumulated stay with the horse.

APPROVED CLASSES AND DESCRIPTIONS

The Following is a list of classes that are approved by KSHA for use in Member shows. Other classes may be added to suit local interest but cannot be counted toward the Annual Awards. Exhibitors must place at least three times in the same class at three separate accredited member shows to qualify for a year end award in that class. Any issue not addressed in KSHA Rule Book is/are subject to breed specifications.

REGISTERED AMERICAN SADDLEBRED

Registration with the American Saddle Horse Association, Inc. required.

Performance Division

No artificial appliances except mane and tail hair, tail braces, and mouth controls. Stripping of horses is mandatory in under saddle championships. Two (2) attendants only.

K001. Registered American Saddlebred Fine Harness Open
(Animated walk, Park trot, Show Your Horses, Stand quietly. Not required to back. 4-wheel buggy without top, Light harness, snaffle bit and overcheck with blinkers. Quarter boots permitted. Attendant permitted in line-up.)

K002. Registered American Saddlebred Saddle Seat Five Gaited Open
(Walk, trot, slow gait, rack, canter. Quarter boots permitted.)

K003. Registered American Saddlebred Three Gaited Open
(Walk, trot and canter)

Show Pleasure Division

Amateur and youth exhibitors only. Stallions prohibited in all classes. Shoe bands and pads are permitted. Cross entry between Pleasure and Country Pleasure and between three- and five-gaited classes is prohibited at the same show. Shown with full mane and tail. Tail sets and ginger prohibited. Pulling, tossing head, going sideways, and switching tail are to be penalized. Emphasis on walk. Judged 75% on performance, presence, quality and manners, 25% on total conformation with breed standards. Stand quietly and back readily.

K004. Registered American Saddlebred Show Pleasure, Amateur Three Gaited English Any Age
(Flat walk, trot, and canter. Full bridle, pelham, or curb only. Ring snaffle prohibited)

K005. Registered American Saddlebred Show Pleasure, Amateur Five Gaited Any Age
(Flat walk, trot, slow gait, rack, and canter. Full bridle, pelham, or curb only. Ring snaffle prohibited. Quarter boots permitted.)

K006. Registered American Saddlebred Show Pleasure, Amateur Pleasure Driving Any Age
(Flat walk, trot, and extended trot. Light harness with snaffle bit and separate overcheck bit, two-wheeled buggy. Headers permitted in line-up at the judge's and show manager's discretion)

Country Pleasure Division

Amateur and youth exhibitors only. Stallions prohibited in all classes. Cross entry between Pleasure and Country Pleasure and between three- and five-gaited classes is prohibited at the same show. Shown with full mane and tail. Tail sets and ginger prohibited. Pulling, tossing head, going sideways, and switching tail are to be penalized. Must be plain shod, no pads. Emphases on walk, 75% on manners and performance, presence, and quality, 25% conformation and neatness of attire with breed standard. Stand quietly on rail and in line-up. Back readily

K007. Registered American Saddlebred Country Pleasure, Amateur Three-Gaited English Any Age
(Flat walk, trot, extended trot, and canter.)

K008. Registered American Saddlebred Country Pleasure, Amateur Three-Gaited Western Any Age
(Flat walk, jog, lope or canter. Western Headstall without noseband. Standard Western bit. Ropes, chaps, and ties optional)

K009. Registered American Saddlebred Country Pleasure, Amateur Five-Gaited Any Age
(Flat walk, trot, slow gait, rack, and canter)

K010. Registered American Saddlebred Country Pleasure, Amateur Pleasure Driving Any Age
(Flat walk, trot, and extended trot. 2- or 4-wheeled buggy with appropriate harness. Headers permitted in line-up at judges and show manager's discretion. Overcheck with separate overcheck bit or sidecheck (separate side check bit is optional) and snaffle bit (straight or jointed).)

K011. Registered American Saddlebred Country Pleasure, Amateur Hunter
(Walk, trot, canter, stand and back. Extended trot and hand gallop optional. Natural tail carriage. May be braided hunter style. Bridle to be snaffle, pelham, full bridle, kimberwicke, light show type, single curb, single snaffle or light bridle. No martingale or tie down.

Halter Division

Shown in bridle or in-hand. Entry must be serviceably sound. Two attendants per animal allowed. Shown

individually standing and at a walk and trot on the line. 50% conformation with breed standards and finish. 50% way of going and natural action.

K012. Registered American Saddlebred Halter Any Age Any Sex

REGISTERED APPALOOSA and POA HORSES

Registration with the Appaloosa Horse Club, Inc. or Pony of America Club (POA) required. 60% performance and manners; 30% type, conformation with breed standards, quality and substance; 10% appointments.

K013. Registered Appaloosa and POA English Pleasure, Open
(Walk, trot, canter with ability to push on. Double or single rein bridle.)

K014. Registered Appaloosa and POA Western Pleasure, Open
(Walk, jog, and lope with ability to push on. Refer to general rule #23. Ropes, chaps, ties optional.)

K015. Registered Appaloosa and POA Halter, Any Age Any Sex
(Shown in Halter only. Not to stretch. No whips. No coloring on hooves. Judged individually standing and at a walk and trot on the line. One handler. 40% conformation with breed standards, 20% type, 20% action. 20% soundness.)

REGISTERED ARABIAN & HALF-ARABIAN HORSES

Registration with the AHA (Arabian Horse Association) required. Arabs are shown with natural, unbraided mane and natural, unset, un-tingered tail. Shoeing: Maximum length toe 4 1/2", maximum weight shoe, 14 oz.; 1 pad not exceeding 3/8".

Half-Arabians must be registered with AHA in the Half-Arabian Registry. They shall be judged on quality, conformation with breed standards, substance and type. Half-Arabian colts/stallions may compete in weanling and yearling halter classes, however at two (2) years and over they are excluded from all halter classes. Half-Arabian colts/stallions may not compete in performance classes. Half-Arabian hunter types, showing under hunter tack, are permitted to carry a braided mane and tail.

K016. Registered Arabian and Half-Arabian English Pleasure, Open
(Flat walk, normal trot, strong trot, canter, hand gallop; extreme speed to be penalized. Full bridle, pelham, single curb, and single snaffle permitted. Hunt or Saddle seat equipment. Stand quietly and back readily)

K017. Registered Arabian and Half-Arabian Western Pleasure, Open
(Flat walk, jog trot, lope, hand gallop; extreme speed to be penalized. Western headstall without noseband, standard Western bit. Refer to general rule #23. Stand quietly and back readily. Ropes, chaps, ties, optional.)

K018. Registered Arabian and Half-Arabian Native Costume, Open
(Walk, canter, hand gallop; extreme speed to be penalized, Stand and back. Bridle with bosal or bit. Fringe or tassels may be added to all equipment. Rider's attire: flowing cape or coat, pantaloons, headdress, scarf, or sash. 75% performance and manners; 25% for appointments.)

K019. Registered Arabian and Half-Arabian Pleasure Driving, Open
(Walk, trot, strong trot, stand quietly and back readily. 2 or 4 wheeled vehicle; light harness, bridle with blinkers, snaffle bit, overcheck or sidecheck with separate bit. Headers permitted.)

K020. Registered Arabian and Half-Arabian Halter, Any Age, Any Sex
(Shown in-hand at a walk and trot. Not to be stretched. A suitable headstall equipped with throatlatch is mandatory. Excessive use of the whip to be penalized. Arabians to be judged on type, conformation with breed standards, substance and quality. Transmissible weaknesses to count strongly against breeding stock.)

DISCIPLINED RAIL

This class is not a game or a fault-and-out competition, but shall be judged based on performance. The judge shall determine the gaits to be called and their order, but safety should be a priority. The judge shall NOT ask participants to dismount. The class will be worked collectively on the rail, and the routine may include but is not limited to walk, jog, trot (a posting trot should only be called if the class is limited to English riders), canter/lope, hand gallop, simple or flying lead changes, Loping from a halt, counter-cantering or counter-loping, sidepass or leg yield, turn on hindquarter and/or forequarter and back.

K021. Disciplined Rail Western

K022. Disciplined Rail English

K023. Disciplined Rail Western/English Walk/Trot Open

ENGLISH PLEASURE

Open to all horses. 70% performance and suitability; 30% conformation with breed standards

Saddle Seat Pleasure

Walk, trot, canter, stand, and back. Extended trot optional. Normal tail carriage. May be braided. Bridle to be light show type, single curb or single snaffle, full bridle or pelham bit. No martingale or tiedown.

K024. Saddle Seat Pleasure Open

K025. Saddle Seat Pleasure 18 and under

K026. Saddle Seat Pleasure 19 and over

Beginners Walk-Trot

Walk, trot, and back. 60% performance, 30% conformation with breed standards, 10% costume. Limited to riders who have not ever shown in any classes in a KSHA show where a canter is a required gait. Riders remain eligible until they enter a KSHA class requiring a canter.

K027. Beginners Walk-Trot Saddle Seat 18 and under

K028. Beginners Walk-Trot Hunt Seat 18 and under

KSHA Approved Adult Walk-Trot

Walk, trot, and back. 60% performance, 30% conformation with breed standards, 10% costume. Limited to riders who are KSHA members and have a KSHA Approved Adult walk/trot application on file. Application must be resubmitted and approved each year. Riders remain eligible until they enter a KSHA class requiring a canter during the show year.

K029. KSHA Approved Adult Walk-Trot Hunt Seat 19 and over

K030. KSHA Approved Adult Walk-Trot Saddle Seat 19 and over

K031. English Saddle Seat Pleasure Limited Any age, breed or sex of horse, any age rider

(Horse cannot have won six (6) blue ribbons in any walk/trot/canter class requiring saddle seat equipment.

Walk, normal trot, canter; back optional. Bridle to be light show type, single curb or single snaffle, curb and snaffle or pelham bit. No martingales or tiedowns.)

K032. Walk/Trot Saddle Seat Open (all ages)

EQUITATION DIVISION

Rider only being judged. Any type horse. Money prizes prohibited. A pattern is optional for Bareback Equitation and Saddle Seat equitation. For Hunt Seat Equitation and Western Horsemanship, a written routine will be followed. For Beginners Equitation Walk Trot Only classes for riders 18 years and under (including splits), the judge may choose one of four suggested patterns found in the KSHA rulebook or supply a pattern of similar difficulty. For KSHA Approved Adult Walk-Trot classes for riders 19 years and over, patterns are required but will be determined by the judge. Individual workouts will be first with rail work second. Each show's judge must supply a separate written routine (pattern) for each division. Patterns are to be posted at least one hour prior to the first class of the session for that class and should be workable in 1 minute or less. In Classes with mandatory workouts, rail work shall be optional.

Bareback Equitation

Walk, trot, canter, may not be asked to dismount. Reverse towards or away from the rail. Western or English attire.

K033. Bareback Equitation 18 and under

K034. Bareback Equitation 19 and over

Beginners Walk-Trot Equitation

Limited to riders who have not ever shown in any class in a KSHA show where a canter is a required gait. Riders remain eligible until they enter a KSHA class requiring a canter or lope.

K035. Beginners Walk-Trot Western Horsemanship 18 and under

K036. Beginners Walk-Trot Saddle Seat Equitation 18 and under

K037. Beginners Walk-Trot Hunt Seat Equitation 18 and under

KSHA Approved Adult Walk-Trot

Limited to riders who are KSHA members and have a KSHA Approved Adult walk/trot application on file. Application must be resubmitted and approved each year. Riders remain eligible until they enter a KSHA class requiring a canter during the show year. Patterns are required but will be determined by judge.

K038. KSHA Approved Adult Walk-Trot Western Horsemanship 19 and over

K039. KSHA Approved Adult Walk-Trot Hunt Seat Equitation 19 and over

K040. KSHA Approved Adult Walk-Trot Saddle Seat Equitation 19 and over

Hunt Seat Equitation - not to jump

Walk, slow trot, posting trot, canter, hand gallop. Full bridle, Pelham or single snaffle with cavesson. Patterns are required.

K041. Hunt Seat Equitation 18 and under (not to jump)

K042. Hunt Seat Equitation 19 and over (not to jump)

Saddle Seat Equitation

Exhibitor may not cross enter Saddle Seat Equitation or Saddle Seat Pleasure Equitation at any show. Walk, trot, and canter. Full bridle (curb and snaffle) or Pelham. Riding habit required with derby and Jodhpur boots. Optional: workout

K043. Saddle Seat Equitation 18 and under

K044. Saddle Seat Equitation 19 and over

Saddle Seat Pleasure Equitation

Exhibitor may not cross enter Saddle Seat Equitation or Saddle Seat Pleasure Equitation at any show. Walk, trot, and canter. Full bridle (curb and snaffle) or Pelham. Informal riding habit with derby and Jodhpur boots required. Optional: workouts. Must ride a pleasure horse of any breed.

K045. Saddle Seat Pleasure Equitation 18 and under

K046. Saddle Seat Pleasure Equitation 19 and over

Western Horsemanship

Walk, jog, lope(except in walk-trot class). Refer to general rule #23. Junior horses may be ridden with two hands. Patterns are required. Time limit is one minute per exhibitor.

K047. Western Horsemanship 18 and under

K048. Western Horsemanship 19 and over

K049. Western Horsemanship Walk-Trot Open

K050. English Equitation (Hunt Seat or Saddle Seat) Walk/Trot Open, All Ages

FOX TROTTERS

Flat walk, foxtrot, and canter. Browband type bridle with or without cavesson. Western style saddle. Refer to general rule #23. Ladies, youth, and junior horses will not canter

- K051.** Fox Trotters Open, rider any age
K052. Fox Trotters Junior Horse, 3 and under, no canter
K053. Fox Trotters Ladies 19 and over, no canter
K054. Fox Trotters Youth 18 and under, no canter

HUNTER

Any breed, height, or sex horse. Must be serviceably sound. Snaffle, pelham, full bridle, or kimberwicke. Judged on even hunting pace, manners and jumping style.

Hunt Seat

Walk, trot, canter, stand and back. Extended trot and hand gallop optional. Natural tail carriage. May be braided per breed specifications. Bridle to be a snaffle, pelham, full bridle or kimberwicke.

- K055.** Hunt Seat Pleasure Open
K056. Hunt Seat Pleasure 18 and under
K057. Hunt Seat Pleasure 19 and over
K058. Hunt Seat Pleasure Junior Horse 5 and under
K059. Hunt Seat Pleasure Senior Horse 6 and over

K060. Walk/Trot Hunt Seat Pleasure all Ages

K061. Hunter Hack

(Walk, trot, canter; gallop one-way. Jump two (2) fences from 2' to 2'6" in height. Require jumps to be spaced in increments of 12' with a minimum of 48' between jumps and a maximum of 72'. Drop noseband prohibited. Protective boots and leg wraps are acceptable.)

K062. Show Hack, Open

(Mane and tail may be braided or roached. English saddle of any type is required. Bridles may be double, pelham, snaffle, full, or kimberwicke. Drop nosebands prohibited. Martingales, breastplates, boots and/or bandages prohibited. Browbands and cavessons other than Hunter or Dressage types are prohibited. Acceptable hack attire is required. Saddle suit and/or Kentucky jodhpurs are prohibited. Horses must enter ring at a walk. To be shown at a collected walk, normal walk, extended walk, collected trot, normal trot, extended trot, collected canter, normal canter, extended canter and hand gallop. Stand and back readily. Any gait can be required from halt. Mounting, dismounting and rein back may also be required. To be judged 55% performance; 20% quality, 15% conformation with breed standards, 10% manners.

Show Hack Gaits defined:

Walk--straight, four beat and flatfooted

Trot--free, light and crisp, may be required as follows: free on a light contact, collected with rider sitting, extended--on contact--medium speed with legs moving forward with impulsion and with rider posting or sitting.

Canter may be required as follows, collected, normal, extended, hand gallop under control.

A well-trained show hack will be able to perform all of these gaits with a noticeable difference in performance, as changes are made from collected to extended gaits.)

K063. Hunter In Hand 14 Hands and Under

(Horse must be two years old or older. To be judged on manners and way of going, keeping an even hunting pace over the course. Judge must penalize unsafe jumping and bad form over fences. To be shown in halter or bridle with appropriate lead. Exhibitor not permitted to go over jumps. Whip may be carried. No wings or additions are allowed outside the jump standards.)

Course: Horses to be shown over a minimum of four fences consisting of at least six jumps, 18" in height; jumps must be at least six feet wide. All jumps must have a ground pole. Jump standards may not be taller than 40" in height. The course must be posted two hours before the class. Obstacles must simulate those found in hunting, such as natural post and rail, brush, stone wall, white board gate, hedge, oxer, etc. An In and Out Jump is not allowed.

Faults: The following faults are scored by the judge depending on severity and may be considered minor or major faults: circling while on course, backing, light touches against an obstacle, kicking, spooking or shying, knockdown of any part of an obstacle, pulling up concourse, dangerous jumping. 3rd accumulated refusal means elimination.

K064. Jumper In Hand 14 Hands and Under

(Same rules as Hunter In Hand 14 Hands and Under with these additions/exceptions: Jumpers are scored on a mathematical basis: Knockdowns = 4 faults, Refusals = 3 faults, Circling = 3 faults. A jump-off is to occur for those horses with clean rounds. All other ties will be jumped-off for concurrent place. The Jump-off will be held over the original course. The height of the jumps shall be increased not less than one (1) inch and not more than six (6) inches in height. An elimination Jump-off does not eliminate the horse from the final placing. Only two jumps in the Jump-off will be raised. When jump height reaches 34", exhibitors will be timed on the course and those times will be used to determine the placings if there are ties in the number of faults.)

LEADLINE

Rider must be three years to 10 years old or challenged rider. Leader must be 14 years and over. Any type horse or pony may be used. Judged on rider's ability, neatness and coordination of attire. (Equipment must be adjusted to rider.) Walk only. No patterns. Costumes may be worn. Has not ridden in any other performance class requiring a gait other than a walk.

K065. Leadline

REGISTERED MINIATURE HORSES

Registration with the American Miniature Horse Association or the American Miniature Horse Registry is required.

K066. Registered Miniature Horse Halter

(Horses to be shown in hand at the walk and trot. Horses must also be viewed in motion from the side. In the case of two animals being judged equal, the higher placement shall be awarded to the smaller animal. In no case, however, shall a smaller horse be placed over a larger horse with better conformation.)

K067. Registered Miniature Horse Open Driving

(Gait requirements-Pleasure driving is to be shown both ways of the arena at a Walk, Pleasure Trot, and an Extended Trot. Horses will enter the ring counter clockwise at a Pleasure Trot. Horses will be required to stand quietly and rein back.

REGISTERED MORGAN HORSES

Registration with the American Morgan Horse Association, Inc. required. Shown with full mane and tail carried naturally. Shoeing: maximum length toe, 4 3/4"; maximum weight, 18 oz., including pads. Stripping of horses in under saddle championships is mandatory. 60% manners and gait; 40% type and conformation with breed standards.

K068. Registered Morgan English Pleasure, Open (hunt or saddle seat)

(Flat walk, pleasure trot, road trot, and canter. Full bridle and saddle seat attire OR Pelham or single snaffle and hunt seat attire. Hunt or Saddle Seat Equipment.)

K069. Registered Morgan Western Pleasure

(Flat walk, jog, lope. Refer to general rule #23.)

K070. Registered Morgan Pleasure Driving, Open

(Flat walk, pleasure trot, and road trot. 2-Wheel vehicle, light harness with overcheck or sidecheck. Header required without whip.)

K071. Registered Morgan In-hand

(Judged individually standing, and at a walk and trot on the line. Must be serviceably sound. Two handlers permitted.)

REGISTERED PAINT/PINTO HORSES

Registration with the American Paint Horse Association or the Pinto Horse Association of America, Inc. or any accredited color registry required. Registered breeding stock horses are eligible to show.

K072. Registered Paint/Pinto English Pleasure, Open (Hunt or Saddle Seat)

(Walk, trot, canter; gallop optional. Hunt seat or saddle seat equipment. Full bridle, pelham, single curb, single snaffle or kimberwicke.)

K073. Registered Paint/Pinto Western Pleasure, Open

(Walk, jog, lope. Refer to general rule #23.)

K074. Registered Paint/Pinto Halter, any age, any sex

(Shown in hand at a walk and trot. Stock type to stand squarely; saddle type may be stretched. Judged on conformation with breed standards, quality, substance, and soundness. Color pattern not to count.)

REGISTERED PALOMINO/BUCKSKIN/DUN HORSES

Registration with the Palomino Horse Association, the Palomino Horse Breeders of America, The American Buckskin Registry of America, or The International Buckskin Horse Association required.

K075. Registered Palomino/Buckskin/Dun English Pleasure, Open (Hung or Saddle Seat)

(Walk, trot, canter; hand gallop optional. Stand quietly and back readily. Hunt seat or Saddle seat equipment. Full bridle, snaffle, pelham, or kimberwicke bit; with cavesson.)

K076. Registered Palomino/Buckskin/Dun Western Pleasure, Open

(Walk, jog, and lope. Stand quietly and back readily. Refer to general rule #23.)

K077. Registered Palomino/Buckskin/Dun Halter, any age, any sex

(Shown in halter or bridle. Judged individually standing, and at a walk and trot on the line. 65% conformation with breed standards, 25% color, 10% manners and way of going.)

PASO FINO HORSES

Reference "Paso Fino Conduct and Specifications" sheet in Judge's Packet.

K078. Paso Fino: Bella Forma (In-hand)

(Shown in a leather halter in-hand without a bit. Matching lead line or long lines required. Conformation with breed standards and gait to be judged. Qualifying Gaits: Classic Fino or Paso Corto. Choice of gaits is optional, with no preference to be given one over the other. Judged 60% conformation with breed standards, 30% on quality and naturalness of gait, and 10% on appearance, grooming and manners.)

K079. Paso Fino: Paso Pleasure (Peruvian Paso Permitted)

(Flat walk: A true, evenly spaced 4 beat, Paso Corto: Mild collection, Paso Largo: Mild collection. Refusal to back disqualifies horse from placing. Dismount and mount may be called for at judges' discretion. Judged 30% on the Paso Corto, 30% on the Paso Largo, 20% on manners, attitude, and way of going, 10% on the flat walk, and 10% on backing. Tack and headgear for horses should be of a variety appropriate and practical for pleasure riding. Attire shall be long sleeved shirt, full-length trousers, riding boots or shoes. Hats and jackets are optional.)

K080. Paso Fino Performance

(Walk (collected), Paso Corto (collected), Paso Largo (collected), Judged 30% on the Paso Corto, 30% on the Paso Largo, 15% on the walk, 15% on appearance and way of going, and 10% on manners. English type tack. Attire must be official Paso Fino show costume.)

PLEASURE DRIVING, OPEN

Any breed horse, 2- or 4- wheeled vehicles with light harness, bridle and blinkers, snaffle bit with overcheck or sidecheck. Shown with full mane and natural tail. No quarter boots. Judged on performance, manners and suitability. Attendant in lineup permitted.

K081. Pleasure Driving Open

(Walk, normal trot, strong trot. Stand quietly and back readily.)

K082. Prairie Pleasure Driving Open

(Open to western or hunter type horses, any size. Horses shown saddle seat at a KSHA show are not eligible in the same calendar year. Vehicle to be in safe and sound condition, 2- or 4 wheeled type, no preference is to be given in judging. Harness to be light use harness or show harness in breast collar or full collar type. Flat walk, regular trot or optional gait and drive on. May be asked to back. Choice of attire is by discretion (must be neat and in good taste). Judged 70% on manners and performance, 15% on neatness, 15% on overall appearance.)

PONY DIVISION

A pony is defined as any equine 14 hands and under or refer to breed or registry standard.

K083. Pony Pleasure Driving, under 14.0

(Must be under 14.0 hands, any breed. Walk, normal trot, and brisk trot. Stand quietly and back readily.)

K084. Pony Pleasure, under 14.0

(Must be under 14.0 hands, any breed. Walk, trot, and canter. English or western.)

K085. Pony Halter, any age, any sex

(To be shown in halter or bridle, standing and in action, on the rail in hand. Maximum Height 14.0H.)

REGISTERED QUARTER HORSES

Registration with the American Quarter Horse Association is required.

K086. Registered Quarter Horses Hunter Under Saddle, Open

(Walk, trot, canter; hand gallop optional. Hunt seat equipment only. Reverse to center only.)

K087. Registered Quarter Horses Western Pleasure, Open

(Walk, jog, lope. Refer to general rule #23. Reverse to center only.)

K088. Registered Quarter Horses Halter, any age, any sex

(Judged individually, standing and at a walk and trot on the line. Must be shown in a halter. Must stand squarely.)

REINING

Bosal or loose cavesson type noseband permitted. Riders' hands must stay clear of horse and saddle. Horses to rein and handle easily with reasonable speed. Collective rail work is not required. Exhibitor may show more than one horse. Pattern to be posted by the judge prior to the start of the show from optional patterns listed at the back of the book.

K089. Reining Open

ROADSTER

Emphasis on trot at three speeds: slow jog trot, fast road trot, and full speed. May be asked to walk, enter clockwise. Stand quietly and back readily. No headers allowed. Must wear colors. Shown to bike or wagon: Harness with square blinkers, snaffle bit, and check rein is required or comply with breed/registry standard. Shown under saddle: English Saddle, full martingale, open bridle with snaffle bit, single or double rein, and quarter boots or comply with breed/registry standard.

K090. Roadster 14.2 and over to bike

K091. Roadster 14.1 and under to bike

K092. Roadster 14.2 and over under saddle

K093. Roadster 14.1 and under to be under saddle

K094. Roadster 14.2 & over combination

K095. Roadster 14.1 and under combination

SIDESADDLE

English, western, or period saddles with corresponding attire permitted. Walk, jog or normal trot, lope or canter. Rider may sit or post the trot. Not to be judged as a costume class. 75% manners, performance, quality and conformation with breed standards; 25% appropriate sidesaddle dress.)

K096. Sidesaddle Ladies

SHOWMANSHIP AT HALTER

Only the showman is to be judged, the horse is merely a prop to show the ability of the showman. Showmanship at halter shall be a separate class from all other in-hand or halter classes. This performance class shall be judged strictly on the contestant's ability to fit and show in an in-hand or halter class. Showmanship at Halter pattern is required. Pattern to be determined by the judge and must be posted prior to the first class of the show.

APPEARANCE OF HORSE (40 points)

Horse to be in good show condition, well groomed with hair coat clean and well brushed. Mane and tail should be clean and free of tangles. Hoofs must be trimmed properly. If shod, shoes must fit properly and clinches should be neat. Horses should be groomed per breed specification. Tack should be neat, clean, and in good repair. Quarter boots are prohibited for American Saddlebred horses.

APPEARANCE OF EXHIBITORS (10 points)

Clothes and person should be neat and clean. The showman should wear suitable Western or English clothes.

SHOWING HORSE IN RING (50 points)

Walk on horse's left side, holding lead shank in right hand near halter. A tightly coiled or rolled lead shank will be considered a fault in showmanship. Horse should lead readily at a walk or trot. A pattern will be posted which requires each exhibitor to work individually. When moving the horse, be sure that the judge gets a clear, unobstructed view of the horse's action. Allow the horse sufficient lead so that he can move freely and in a straight line. Lead the horse from his left side the required distance, stop and turn to the right around the horse.

When posing the horse, stand toward the front facing the horse, but always in a position where you can keep your eye on the judge. Pose your horse with its feet squarely under it. Do most of the showing with the lead shank. Never kick your horse's leg into position. Do not crowd exhibitors next to you when lined up head to tail. When judge is observing the other horses, let yours stand if posed reasonably well. Be natural. Over showing, undue fussing and maneuvering are objectionable. For example, a 90 degree left turn is preferable to a 270 degree right turn, unless the 270 degree right turn is specifically called for in the pattern.

Keep alert and aware of the position of the judge at all times. Do not be distracted by persons or things outside the ring. Show horse at all times. Respond quickly to requests from the judge and officials. Be courteous and sportsmanlike at all times. Recognize quickly and correct faults of your horse. Keep showing until the entire class has been placed and has been excused from the ring.

K097. Beginner's Showmanship at Halter

(Must be accompanied by someone over the age of 14 to assist. The exhibitor cannot have shown in any other in-hand or halter class. Proper show ring attire should be worn by exhibitor and assistant.)

K098. Showmanship at Halter 10 and under

K099. Showmanship at Halter 11-18

K0100. Showmanship at Halter 19 and over

REGISTERED TENNESSEE WALKING HORSES

K0101. Registered Tennessee Walking Horse Open

(Flat walk, running walk, canter. Judges will penalize entries out of form. Only tail brace, switch, or humane tails allowed. Bumping and pumping penalized. A tendency to rack, pace, slow gait, or any other deviation from the true gaits shall be penalized. In championship classes, horses must be stripped. All horses exhibited must comply with USDA rules for shoeing, appliances used, and inspection.)

K0102. Registered Tennessee Walking Horse Country Pleasure

(Flat walk, running walk—NO CANTER. Stand quietly and back readily. Bumping and pumping to be penalized. Hoof bands, action devices, and pads prohibited. Ribbons are optional, tails must be natural. Western or English equipment. Shoe maximum ½" thick, 1 ½" wide with no bar plates or weight inside shoe. Calks maximum ½" in width and length. Shoe must not extend more than ¼" beyond hoof on all sides. Judged on manners, performance, quality, and substance.)

K0103. Registered Tennessee Walking Horse Plantation Pleasure Open

(Flat walk, running walk, canter. Stand quietly and back readily. Bumping and pumping to be penalized. Hoof bands, action devices, and pads prohibited. Plain shod shoe maximum ½" thick, 1 ½" wide with no bar plates or weight inside shoe. Ribbons are optional, tails must be natural.)

K0104. Registered Tennessee Walking Horse Park Pleasure Open

(A personal park pleasure mount. Flat walk, running walk, canter. Stand quietly and back readily. Bumping and pumping to be penalized. Hoof bands and action devices permitted. Ribbons are optional, tails must be natural.)

K0105. Registered Tennessee Walking Horse Park Pleasure Specialty, Amateur

(A personal park pleasure mount. Flat walk, running walk, NO CANTER. Stand quietly and back readily. Bumping and pumping to be penalized. Hoof bands and action devices permitted. Ribbons are optional, tails must be natural.)

K0106. Registered Tennessee Walking Horse Show Pleasure, Amateur

(Flat walk, running walk, canter. Stand quietly and back readily. Bumping and pumping to be penalized. Hoof bands permitted. Action devices prohibited. Ribbons are optional, tails must be natural.)

K0107. Registered Tennessee Walking Horse Halter, Model Class, any age, any sex

(Horses need not be shown in action. Emphasis placed on type, quality, presence, and conformation with breed standards. Visible unsoundness and blemishes shall be penalized.)

TRAIL HORSE

Course should be set up in a manner such that it may be executed in approximately five (5) minutes. Required to work over or through obstacles. Course must consist of at least five (5) obstacles. After three (3) refusals, the horse must move on to the next obstacle. Pattern must be posted by the judge prior to the start of the show. Western or English tack is permitted.

Courses should be designed with safety in mind so as to eliminate any accidents. Obstacles may include but are not limited to:

- Opening, passing through, and closing gate.
- Ride over logs or poles. Poles can be in a straight line, curved, zigzag, or raised (maximum height 8").
 - Spacing for walkovers shall be 20" to 24"
 - Spacing for trotovers shall be 3' to 3'6"
 - Spacing for lopeovers shall be 6' to 7'
- Backing obstacle, such as a cloverleaf pattern, L, V, or U. Participants shall not be asked to back over an obstacle such as a pole.
- Serpentine obstacles at walk or jog (minimum of 6' for jog)
- Carry object from one part of arena to another (object must be small enough to carry without dragging and something that might be reasonably carried horseback).
- Ride over wooden bridge at a walk. Flat bridges may have an additional element such as a walkover pole.
- Put on and remove slicker.
- Remove and replace materials from mailbox.
- Sidepass (horses shall not be asked to sidepass with any object between their front and rear legs except for a wooden log or pole).
- Turn inside a square. Turns may be 180, 270, 360 or more degrees. Markers for the square may include wooden poles/logs, bridge, or cones.
- Ground Tie
- Dismount (Dismounting is acceptable as part of the final obstacle if a remount is not required)

Unacceptable obstacles include:

- Tires
- Animals
- Hides
- PVC pipe (exception: classes limited to horses/ponies 14.0 hands and under)
- Jumps
- Rocking or moving bridges
- Water box with floating or moving parts
- Flames, dry ice, fire extinguisher, etc.
- Logs or poles elevated in a manner that permits them to roll
- Ground poles made of foam ("noodles")
- Remount

Horses are not to be required to work on rail. Course must be designed, however, to require each horse to show the required gaits according to the approved class (Open: walk, jog and lope; Walk-Trot: walk and jog only) somewhere between obstacles as part of its work. The trail horse class may be held in an adjacent area during the show and be judged by a qualified person.

Prior to the start of the class, the judge must walk the course and has the right to remove or change any obstacle he/she deems unsafe or non-negotiable. If three members of the Rules Committee deem an obstacle unsafe or non-negotiable, the obstacle will be repaired or removed. Riders will be permitted to inspect the course on foot without their horses during the judge's walk-through. At this time, at the judge's discretion, the riders may ask questions and/or the judge may walk the riders through the course. A minimum of five minutes, but not to exceed ten minutes, will be allowed for the walk-through.

K0108. Trail Horse Open

K0109. Beginner Walk-Trot Trail 18 and under

(Limited to riders who have not ever shown in any classes in a KSHA show where a canter or lope is a required gait. Riders remain eligible until they enter a KSHA class requiring a canter or lope.)

K0110. KSHA Approved Adult Trail 19 and over Walk-Trot

(Limited to riders who are KSHA members and have a KSHA Approved Adult walk/trot application on file. Application must be resubmitted and approved each year. Riders remain eligible until they enter a KSHA class requiring a canter or lope during the show year.)

K0111. In-Hand Trail

(Open to all horses regardless of age or breed, and all exhibitors except those currently competing in Beginner's Showmanship. Horses competing in in-hand trail may not compete in an under-saddle trail class at the same show. To be shown at a walk and trot. No tack except a halter and lead allowed. A silver show halter shall not be counted above a good working halter.)

VERSATILITY

This class is an all breed class in which the same rider shows the horse first under Western tack both ways of the ring and then under English tack both ways of the ring. Each entry is allowed two attendants and the time allowed to change the tack (without leaving the arena) will be at the discretion of the judge. No wheeled carrier or saddle/tack racks allowed. The class will be judged by both Western Pleasure and English Pleasure rules, with neither to count for more than 50% of the final decision.

K0112. Versatility Class

WESTERN PLEASURE

60% performance, 30% conformation with breed standards, 10% appointments. Stock saddle. Refer to general rule #23.

Western Pleasure

Walk, jog, lope. (No lope in Western Pleasure Walk/Trot Open.) Hackamores, cavessons, martingales, and tiedowns prohibited

K0113. Western Pleasure, Junior Horse (5 and under)

K0114. Western Pleasure, Senior Horse (6 and over)

K0115. Western Pleasure, 19 and over

K0116. (reserved)

K0117. Western Pleasure, 18 and under

K0118. Western Pleasure, Open

K0119. Western Pleasure Walk-Trot Open

Beginners Walk-Trot

Walk, jog, stand and back. Limited to riders who have not ever shown in any classes in a KSHA show where a canter or lope is a required gait. Riders remain eligible until they enter a KSHA class requiring a canter.

K0120. Beginners Walk-Trot Western Pleasure 18 and under

KSHA Approved Adult Walk-Trot

Walk, jog, stand and back. Limited to riders who are KSHA members and have a KSHA Approved Adult walk/trot application on file. Application must be resubmitted and approved each year. Riders remain eligible until they enter a KSHA class requiring a canter during the show year.

K0121. KSHA Approved Adult Walk-Trot Western Pleasure 19 and over

NON-BREED SPECIFIC HALTER (for non-registered or KSHA unrepresented breeds)

This class is for any horse that is not registered or their registered breed does not have a point halter class in KSHA. To be shown in halter or bridle, standing and in action on the rail in hand according to the breed standards for the horse. May not show in any other halter breed class.

K0122. Non-Breed Specific Halter

REGISTERED FRIESIAN IN-HAND

All horses are to be presented in hand. The handler may have an assistant who encourages the horse to be attentive while standing and to move forward vigorously at the walk and trot. Presentation will require that the horse stand squarely for evaluation of conformation and then walk and trot a triangular pattern for evaluation of movement.

K0123. Registered Friesian In-Hand

SUPER HORSE

General Rules – This special event is designed to promote and enhance the pleasure of riding a versatile horse. Each horse competing is allowed three people in the holding area during the entire event, with two of those people being allowed to ride chosen sections. Once the horse, people and equipment have entered the arena there shall be no changes of people or equipment once the gate has closed. A three minute timed tack change will be allowed between each discipline. Tack, Equipment and Apparel shall follow the guidelines pertaining to that discipline.

Points will be awarded based on the final placing of all eligible horses and according to the existing point schedule. Credits received in each discipline will be totaled and the score should be announced on the public address system, if possible, after totaling credits; the horse receiving the highest number of credits will be placed first in the Super Horse Competition. The horse receiving the second highest credits will be placed second and so on.

Following is a list of the disciplines. Breed rules will be used to judge each horse for each section. All riders in the competition shall comply with and follow rules of attire, equipment, class procedures, patterns, judging and conduct for the class. Preferably in this order: 1st Halter, 2nd English Pleasure, 3rd Western Pleasure, 4th One timed event, either: Barrels, Keyhole, or Poles. Show management will select which timed event.

K0124. Super Horse

WESTERN RIDING

Western Riding is neither a stunt nor a race, but it should be done with reasonable speed. It is a competition in the performance of a sensible, well mannered, free and easy moving ranch horse which can get its rider around on the usual ranch chores, over the trails, or give a quiet comfortable and pleasant ride in open country through and over obstacles.

Scoring will be 60 to 80, with 70 denoting an average performance.

The contestants will be judged on riding qualities of gaits (walk, jog, and lope), change of leads, response to the rider, manners, disposition and intelligence. It is important that the horse correctly change leads at the lope (flying change) while riding the pattern. Lead changes should be made as near the halfway point between markers as practicable.

The following pattern and routine are prescribed. It is essential that the judge and exhibitors adhere to it.

The nine (9) small o's with crosses in them represent markers (pylons are recommended). These should be separated by a uniform distance of not less than thirty nor more than fifty feet on the side, with five (5) markers. The

rectangle represents an obstacle, (one small log is recommended), just high enough to break the animal's stride. The long and sometimes twisting lines indicate the direction to travel and the gaits at which the horse is to move. The dotted line indicates walk, the dashed line jog, and the solid line lope.

Any horse not following the exact pattern will be disqualified. The judge may require an exhibitor to repeat any part of the routine. Except for junior horses shown in a hackamore or snaffle bit, only one hand may be used on the reins and hands must not be changed.

Hands to be around reins, index finger only between reins is permitted. While the horse is in motion, the rider's hands shall be clear of the horse and the saddle. Spurs or romal shall not be used forward of the cinch.

Exhibitors will enter individually to work the pattern. A copy of the required pattern for this class will be posted before the class begins.

K0125. Western Riding

Instructions for the pattern are:

1. Walk and jog over log.
2. Transition to left lead and lope around end.
3. First line change.
4. Second line change.
5. Third line change.
6. Fourth line change lope around the end of the arena.
7. First crossing change.
8. Second crossing change.
9. Lope over log.
10. Third crossing change.
11. Fourth crossing change.
12. Lope up the center, stop, and back.

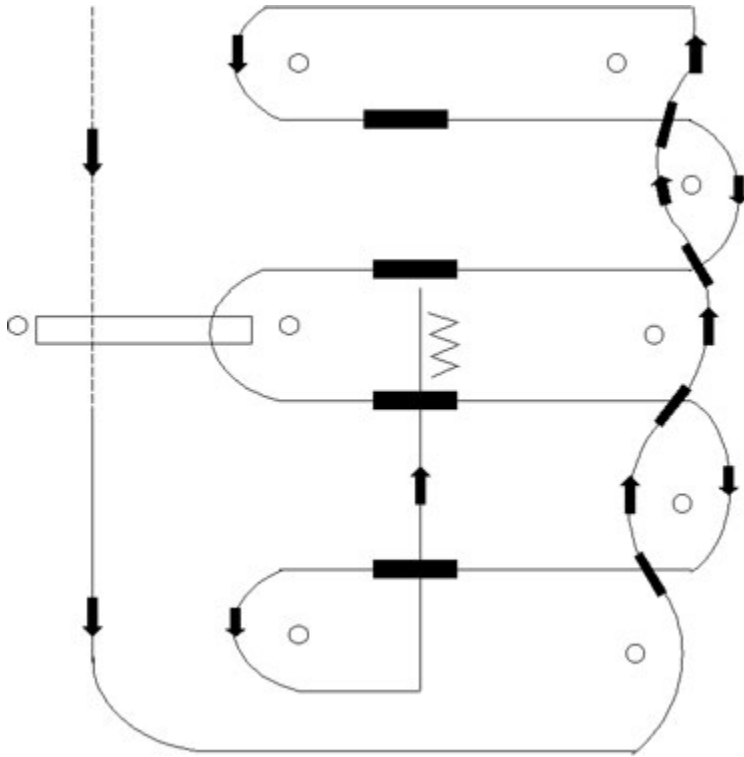

Walk Whoa 18 and Under or Challenged Rider (Western or English)

Judged on exhibitors riding ability. Any type horse or pony. Equipment must be adjusted for rider. Exhibitor shall be accompanied by a helper age 14 and over. Horse may wear a halter over or under bridle. Helper may have a leadline in case of need. This class is open to exhibitors who have not ridden in any other class requiring gaits other than walk or whoa.

K0126. Walk-Whoa 18 and under or Challenged Rider Pleasure (Western or English)

(Rail class, exhibitor shall be asked to walk and whoa, turn horse, may be asked to back. No pattern.)

K0127. Walk-Whoa 18 and under or Challenged Rider Equitation (Western or English)

(Rail and/or Pattern class, exhibitor shall be asked to walk and whoa, turn horse, may be asked to back. Pattern Optional.)

RANCH RIDING

The purpose of Ranch Riding should reflect the versatility, attitude, and movement of a working horse. The horse's performance should simulate a horse riding outside the confines of an arena and that of a working ranch horse. This class should show the horse's ability to work at a forward, working speed while under control by the rider. Light contact should be rewarded and horse shall not be shown on a full drape of reins. The overall manners and responsiveness of the horse while performing the maneuver requirements, and the horse's quality of movement are the primary considerations. Horse may cross enter in other Western Pleasure Classes. Pattern to be posted by the judge prior to the start of the show from optional patterns listed at the back of the book.

Class requirements:

1. Each horse will work individually; performing both required and optional maneuvers, and scored on the basis of 0 to 100, with 70 denoting an average performance.

2. The overall cadence and performance of the gaits should be as those described in GAITS, with an emphasis on forward movement, free flowing, and ground covering for all gaits. Transitions should be performed where designated, with smoothness and responsiveness.
3. Posting at the extended trot is acceptable.
4. Touching or holding the saddle horn is acceptable.

Ranch Riding Apparel and Equipment

1. Hoof polish is discouraged.
2. Braided or banded manes & tail extensions is discouraged.
3. Trimming inside ears is discouraged.
4. Trimming bridle path is allowed, also trimming of fetlocks or excessive (long) facial hair.
5. Equipment with silver should not count over a good working outfit. Silver on bridles and saddles is discouraged but NOT a cause for Disqualification.

Ranch Riding Penalties. A contestant shall be penalized each time the following occur:

1. One (1) point penalties
 - a. Too slow/per gait
 - b. Over-Bridled
 - c. Out of Frame
 - d. Break of gait at walk or trot for 2 strides or less
 - e. Split log at lope
2. Three (3) point penalties
 - a. Break of gait at walk or trot for more than 2 strides
 - b. Break of gait at lope
 - c. Wrong lead or out of lead
 - d. Draped reins
3. Five (5) point penalties
 - a. Blatant disobedience (kick, bite, buck, rear, etc.)
4. Placed below horses performing all maneuvers
 - a. Eliminates maneuver
 - b. Incomplete maneuver
5. Zero (0) score
 - a. Willful abuse
 - b. Major disobedience or schooling
6. No specific penalties will be incurred for nicks/hits on logs but deduction may be made in maneuver score.
7. No specific penalties will be incurred for over/under spins but deduction may be made in maneuver score.
8. Off pattern will NOT be cause for a DQ but will not place above a correct pattern.

K0128. Ranch Riding

OBSTACLE DRIVING

Horses, Ponies, Miniatures are required to work over and through obstacles. The course must accommodate suitable two (2) or four (4) -wheel vehicles. Horses in the obstacle driving class must not be asked to jump over any obstacles, but may be asked to drive over flat obstacles. Obstacles should simulate conditions normally encountered on a pleasant afternoon drive. This is not a timed event, and the speed with which the course is completed should not be used in whole or in part to determine placing. A minimum of 4 and a maximum of 6 obstacles.

Suggested obstacles unique to driving:

1. Positioning one (1) wheel (rear wheel if four (4) -wheel vehicle) within a 24" minimum circle, pivot the Pinto 360° in either direction, maintaining the position of the wheel within the circle.
2. Back the horse until an obstacle is bumped. Dislodging a jump could be used to evidence sufficient backing.
3. Drive in a straight line, keeping one wheel between a 12" minimum designated strip.

4. Drive over a flat obstacle such as water, flat plywood, or firmly anchored tarp.
5. Mount or dismount from either side of vehicle.
6. Carry objects in the vehicle.
7. Half circle serpentine, trot through cones
 - a. Horse course set nineteen (19) feet between cones.
 - b. Pony course set seventeen (17) feet between cones.
 - c. Miniature course set fifteen (15) feet between cones.
8. Back & Walk-through half-circle serpentine
 - a. Pony course set seventeen (17) feet between cones.
 - b. Miniature course set fourteen & one-half (14 1/2) feet between cones.
9. Deviation serpentine, trot through cones.
 - a. Horse and utility horse course set twenty-one (21) feet between cones.
 - b. Pony course set nineteen (19) feet between cones.
 - c. Miniature course set sixteen and one-half (16 1/2) feet between cones.
10. Drive through U.
 - a. Horse course set at ten (10) feet at IN and set at twelve (12) feet at OUT for walk through.
 - b. Pony course set at ten (10) feet at IN and set at ten (10) at OUT for walk through.
 - c. Miniature course set at ten (10) feet at IN and set at ten (10) feet at OUT for walk through.
 - d. For trot through, add two (2) feet to each dimension listed above.
11. Other SAFE Obstacles the Judge approves.

K0129. Obstacle Driving

BABY HALTER 2 AND UNDER

For horses / ponies / miniatures 2 years old and under. To be judged by breed standard. May cross enter into respective breed class.

K0130. Baby Halter 2 and Under

LONG LINE YEARLING AND 2 YEAR OLD

Refer to national Snaffle Bit for core rules. Yearlings may not be saddled, 2 year olds may be shown with or without a saddle. 2 year olds may be shown longe line and ridden at the same show. Exhibitors may show more than 1 horse.

K0131. Longe Line Yearling and 2 Year Old

PARADE HORSE/PONY OPEN

1. Appointments
 - a. Horse OR Pony to be shown with stock saddle, standard bridle, plain or with silver, Mexican or other appropriate equipment. Breastplates, hip drops and serapes are optional.SSE
 - b. Boots or bandages, any kind of martingale, tie-down or draw reins are prohibited.
 - c. Entry shall be serviceably sound and shall be shown with full or shortened mane and tail. Roached mane or tail prohibited.
 - d. Exhibitors shall wear colorful attire of American, Mexican or Spanish origin, consisting of fancy cowboy suit, hat and boots; or dress Western clothing. Spurs, gloves, whip or crop optional.
 - e. Exhibitors may use either one (1) hand or two (2) hands on reins, but may not change method of holding reins or rein hand during class.
 - f. Braids – Saddle type style braiding is optional in all classes for all types of horses. Braiding may be fancy (i.e., rosettes), but must be unobtrusive and tasteful. Tail decorations are optional. The fact that an entry is or is not braided shall not be taken into consideration in the judging of a class, but entries braided in a non-conforming manner shall be penalized.

2. Presentation

- a. Entries shall enter the ring at a Parade gait or Parade trot. Martial music is suggested whenever possible.
- b. Entries shall be shown without artificial appliances except inconspicuously applied tail switch or cap. Vertical tail to be discouraged.
- c. Qualifying Gaits
 - i. The Parade gait shall be true, straight, prancing movement, square, collected and balanced, with hocks well under. Speed shall not exceed five (5) miles per hour.
 - ii. The Parade trot shall be straight, square, collected and balanced, with hocks well under. Speed shall not exceed five (5) miles per hour.
- d. To be shown at a walk, either regular or animated, and Parade gait or Parade trot, both ways of the ring.
- e. Reverse shall be executed at the walk.
- f. To halt and stand quietly from both the walk and Parade gait or Parade trot.
- g. Entries not required to back.
- h. To be judged on performance, manners, appointments, conformation and suitability.

K0132. Parade Horse/Pony Open

RANCH RAIL PLEASURE

Ranch rail pleasure measures the ability of the horse to be a pleasure to ride while performing ranch tasks and should reflect the versatility, attitude, and movement of the working horse. The following gates are required: Walk, extended walk, trot, extended trot, lope, extended lope, stop, reverse and back. Working equipment preferred, silver and bling will not be a disqualification.

K0133. Ranch Rail Pleasure Class, Open

LIST OF CLASSES WITH NO DESCRIPTION

<u>K001.</u>	Registered American Saddlebred Fine Harness Open
<u>K002.</u>	Registered American Saddlebred Saddle Seat Five Gaited Open
<u>K003.</u>	Registered American Saddlebred Three Gaited Open
<u>K004.</u>	Registered American Saddlebred Show Pleasure, Amateur Three Gaited English Any Age
<u>K005.</u>	Registered American Saddlebred Show Pleasure, Amateur Five Gaited Any Age
<u>K006.</u>	Registered American Saddlebred Show Pleasure, Amateur Pleasure Driving Any Age
<u>K007.</u>	Registered American Saddlebred Country Pleasure, Amateur Three-Gaited English Any Age
<u>K008.</u>	Registered American Saddlebred Country Pleasure, Amateur Three-Gaited Western Any Age
<u>K009.</u>	Registered American Saddlebred Country Pleasure, Amateur Five-Gaited Any Age
<u>K010.</u>	Registered American Saddlebred Country Pleasure, Amateur Pleasure Driving Any Age
<u>K011.</u>	Registered American Saddlebred Country Pleasure, Amateur Hunter
<u>K012.</u>	Registered American Saddlebred Halter Any Age Any Sex
<u>K013.</u>	Registered Appaloosa and POA English Pleasure, Open
<u>K014.</u>	Registered Appaloosa and POA Western Pleasure, Open
<u>K015.</u>	Registered Appaloosa and POA Halter, Any Age Any Sex
<u>K016.</u>	Registered Arabian and Half-Arabian English Pleasure, Open
<u>K017.</u>	Registered Arabian and Half-Arabian Western Pleasure, Open
<u>K018.</u>	Registered Arabian and Half-Arabian Native Costume, Open
<u>K019.</u>	Registered Arabian and Half-Arabian Pleasure Driving, Open
<u>K020.</u>	Registered Arabian and Half-Arabian Halter, Any Age, Any Sex
<u>K021.</u>	Disciplined Rail Western
<u>K022.</u>	Disciplined Rail English
<u>K023.</u>	Disciplined Rail Western/English Walk/Trot Open
<u>K024.</u>	Saddle Seat Pleasure Open
<u>K025.</u>	Saddle Seat Pleasure 18 and under

<u>K026.</u>	Saddle Seat Pleasure 19 and over
<u>K027.</u>	Beginners Walk-Trot Saddle Seat 18 and under
<u>K028.</u>	Beginners Walk-Trot Hunt Seat 18 and under
<u>K029.</u>	KSHA Approved Adult Walk-Trot Hunt Seat 19 and over
<u>K030.</u>	KSHA Approved Adult Walk-Trot Saddle Seat 19 and over
<u>K031.</u>	English Saddle Seat Pleasure Limited Any age, breed or sex of horse, any age rider
<u>K032.</u>	Walk/Trot Saddle Seat Open (all ages)
<u>K033.</u>	Bareback Equitation 18 and under
<u>K034.</u>	Bareback Equitation 19 and over
<u>K035.</u>	Beginners Walk-Trot Western Horsemanship 18 and under
<u>K036.</u>	Beginners Walk-Trot Saddle Seat Equitation 18 and under
<u>K037.</u>	Beginners Walk-Trot Hunt Seat Equitation 18 and under
<u>K038.</u>	KSHA Approved Adult Walk-Trot Western Horsemanship 19 and over
<u>K039.</u>	KSHA Approved Adult Walk-Trot Hunt Seat Equitation 19 and over
<u>K040.</u>	KSHA Approved Adult Walk-Trot Saddle Seat Equitation 19 and over
<u>K041.</u>	Hunt Seat Equitation 18 and under (not to jump)
<u>K042.</u>	Hunt Seat Equitation 19 and over (not to jump)
<u>K043.</u>	Saddle Seat Equitation 18 and under
<u>K044.</u>	Saddle Seat Equitation 19 and over
<u>K045.</u>	Saddle Seat Pleasure Equitation 18 and under
<u>K046.</u>	Saddle Seat Pleasure Equitation 19 and over
<u>K047.</u>	Western Horsemanship 18 and under
<u>K048.</u>	Western Horsemanship 19 and over
<u>K049.</u>	Western Horsemanship Walk-Trot Open
<u>K050.</u>	English Equitation (Hunt Seat or Saddle Seat) Walk/Trot Open, All Ages
<u>K051.</u>	Fox Trotters Open, rider any age
<u>K052.</u>	Fox Trotters Junior Horse, 3 and under, no canter
<u>K053.</u>	Fox Trotters Ladies 19 and over, no canter
<u>K054.</u>	Fox Trotters Youth 18 and under, no canter
<u>K055.</u>	Hunt Seat Pleasure Open
<u>K056.</u>	Hunt Seat Pleasure 18 and under
<u>K057.</u>	Hunt Seat Pleasure 19 and over
<u>K058.</u>	Hunt Seat Pleasure Junior Horse 5 and under
<u>K059.</u>	Hunt Seat Pleasure Senior Horse 6 and over
<u>K060.</u>	Walk/Trot Hunt Seat Pleasure all ages
<u>K061.</u>	Hunter Hack
<u>K062.</u>	Show Hack, Open
<u>K063.</u>	Hunter In Hand 14 Hands and Under
<u>K064.</u>	Jumper In Hand 14 Hands and Under
<u>K065.</u>	Leadline
<u>K066.</u>	Registered Miniature Horse Halter
<u>K067.</u>	Registered Miniature Horse Open Driving
<u>K068.</u>	Registered Morgan English Pleasure, Open (hunt or saddle seat)
<u>K069.</u>	Registered Morgan Western Pleasure
<u>K070.</u>	Registered Morgan Pleasure Driving, Open
<u>K071.</u>	Registered Morgan In-hand
<u>K072.</u>	Registered Paint/Pinto English Pleasure, Open (Hunt or Saddle Seat)
<u>K073.</u>	Registered Paint/Pinto Western Pleasure, Open
<u>K074.</u>	Registered Paint/Pinto Halter, any age, any sex
<u>K075.</u>	Registered Palomino/Buckskin/Dun English Pleasure, Open (Hung or Saddle Seat)
<u>K076.</u>	Registered Palomino/Buckskin/Dun Western Pleasure, Open
<u>K077.</u>	Registered Palomino/Buckskin/Dun Halter, any age, any sex
<u>K078.</u>	Paso Fino: Bella Forma (In-hand)
<u>K079.</u>	Paso Fino: Paso Pleasure (Peruvian Paso Permitted)
<u>K080.</u>	Paso Fino Performance
<u>K081.</u>	Pleasure Driving Open

<u>K082.</u>	Prairie Pleasure Driving Open
<u>K083.</u>	Pony Pleasure Driving, under 14.0
<u>K084.</u>	Pony Pleasure, under 14.0
<u>K085.</u>	Pony Halter, any age, any sex
<u>K086.</u>	Registered Quarter Horses Hunter Under Saddle, Open
<u>K087.</u>	Registered Quarter Horses Western Pleasure, Open
<u>K088.</u>	Registered Quarter Horses Halter, any age, any sex
<u>K089.</u>	Reining Open
<u>K090.</u>	Roadster 14.2 and over to bike
<u>K091.</u>	Roadster 14.1 and under to bike
<u>K092.</u>	Roadster 14.2 and over under saddle
<u>K093.</u>	Roadster 14.1 and under to be under saddle
<u>K094.</u>	Roadster 14.2 & over combination
<u>K095.</u>	Roadster 14.1 and under combination
<u>K096.</u>	Sidesaddle Ladies
<u>K097.</u>	Beginner's Showmanship at Halter
<u>K098.</u>	Showmanship at Halter 10 and under
<u>K099.</u>	Showmanship at Halter 11-18
<u>K0100.</u>	Showmanship at Halter 19 and over
<u>K0101.</u>	Registered Tennessee Walking Horse Open
<u>K0102.</u>	Registered Tennessee Walking Horse Country Pleasure
<u>K0103.</u>	Registered Tennessee Walking Horse Plantation Pleasure Open
<u>K0104.</u>	Registered Tennessee Walking Horse Park Pleasure Open
<u>K0105.</u>	Registered Tennessee Walking Horse Park Pleasure Specialty, Amateur
<u>K0106.</u>	Registered Tennessee Walking Horse Show Pleasure, Amateur
<u>K0107.</u>	Registered Tennessee Walking Horse Halter, Model Class, any age, any sex
<u>K0108.</u>	Trail Horse Open
<u>K0109.</u>	Beginner Walk-Trot Trail 18 and under
<u>K0110.</u>	KSHA Approved Adult Trail 19 and over Walk-Trot
<u>K0111.</u>	In-Hand Trail
<u>K0112.</u>	Versatility Class
<u>K0113.</u>	Western Pleasure, Junior Horse (5 and under)
<u>K0114.</u>	Western Pleasure, Senior Horse (6 and over)
<u>K0115.</u>	Western Pleasure, 19 and over
<u>K0116.</u>	(reserved)
<u>K0117.</u>	Western Pleasure, 18 and under
<u>K0118.</u>	Western Pleasure, Open
<u>K0119.</u>	Western Pleasure Walk-Trot Open
<u>K0120.</u>	Beginners Walk-Trot Western Pleasure 18 and under
<u>K0121.</u>	KSHA Approved Adult Walk-Trot Western Pleasure 19 and over
<u>K0122.</u>	Non-Breed Specific Halter
<u>K0123.</u>	Registered Friesian In-Hand
<u>K0124.</u>	Super Horse
<u>K0125.</u>	Western Riding
<u>K0126.</u>	Walk-Whoa 18 and under or Challenged Rider Pleasure (Western or English)
<u>K0127.</u>	Walk-Whoa 18 and under or Challenged Rider Equitation (Western or English)
<u>K0128.</u>	Ranch Riding
<u>K0129.</u>	Obstacle Driving
<u>K0130.</u>	Baby Halter 2 and Under
<u>K0131.</u>	Longe Line Yearling and 2 Year Old
<u>K0132.</u>	Parade Horse/Pony Open
<u>K0133.</u>	Ranch Rail Pleasure Class, Open

REINING PATTERNS

REINING PATTERN NUMBER 1

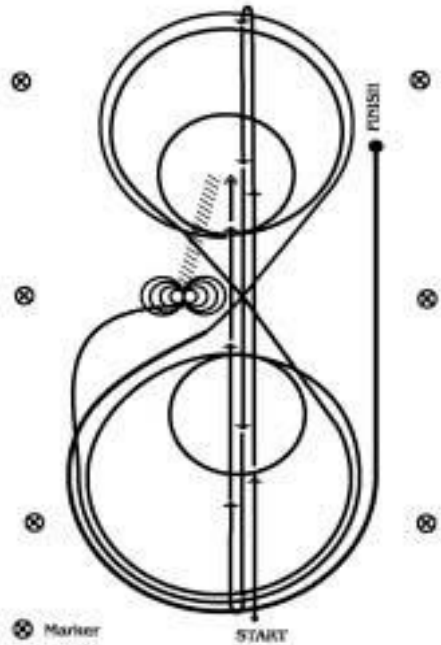

1. Run at speed to the far end of the arena past the end marker and do a left rollback - no hesitation.
2. Run to the opposite end of the arena past the end marker and do a right rollback - no hesitation.
3. Run past the center marker and do a sliding stop. Back up to center of the arena or at least ten feet (3 meters). Hesitate.
4. Complete four spins to the right.
5. Complete four and one-quarter spins to the left so that horse is facing left wall or fence. Hesitate.
6. Beginning on the left lead, complete three circles to the left: the first circle large and fast; the second circle small and slow; the third circle large and fast. Change leads at the center of the arena.
7. Complete three circles to the right: the first circle large and fast; the second circle small and slow; the third circle large and fast. Change leads at the center of the arena.
8. Begin a large fast circle to the left but do not close this circle. Run straight up the right side of the arena past the center marker and do a sliding stop at least twenty feet (6 meters) from wall or fence. Hesitate to demonstrate the completion of the pattern.

Rider may drop bridle to the designated judge.

REINING PATTERN NUMBER 2

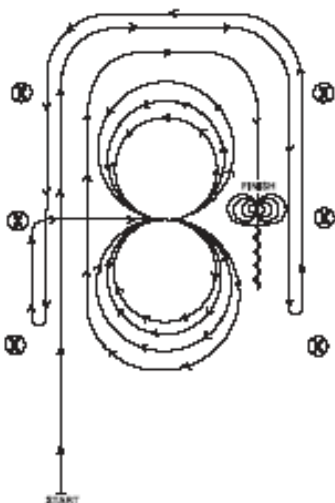

1. Beginning, and staying at least twenty feet (6 meters) from the walls or fence, lope straight up the left side of the arena, circle the top end of the arena, run straight down the opposite or right side of the arena past the center marker and do a left rollback - no hesitation.
2. Continue straight up the right side of the arena staying at least twenty feet (6 meters) from the wall or fence, circle back around the top of the arena, run straight down the left side of the arena past the center marker and do a right rollback - no hesitation.
3. Continue up the left side of the arena to the center marker. At the center marker, the horse should be on the right lead. Guide the horse to the center of the arena on the right lead and complete three circles to the right: the first two circles large and fast; the third circle small and slow. Change leads at the center of the arena.
4. Complete three circles to the left: the first two circles large and fast; the third circle small and slow. Change leads in the center of the arena.
5. Begin a large fast circle to the right but do not close this circle. Continue up the left side of the arena staying at least twenty feet (6 meters) from the wall or fence, circle the top of the arena, run straight down the opposite or right side of the arena past the center marker and do a sliding stop. Back up at least ten feet (3 meters). Hesitate.
6. Complete four spins to the right.
7. Complete four spins to the left. Hesitate to demonstrate completion of the pattern.

Rider may drop bridle to the designated judge.

REINING PATTERN NUMBER 3

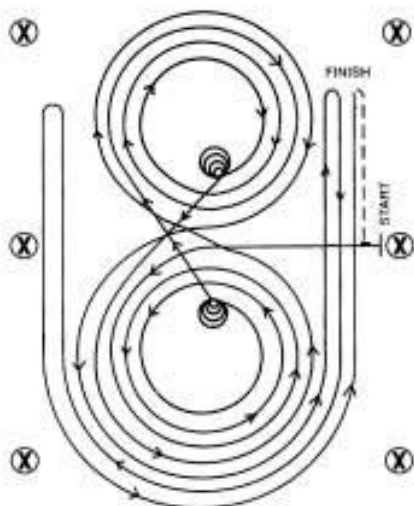

Horse must walk or stop prior to starting pattern.

Beginning at the center of the arena facing the left wall or fence.

1. Beginning on the left lead, complete three circles to the left: the first two circles large and fast; the third circle small and slow. Stop at the center of the arena.
2. Complete four spins to the left. Hesitate.
3. Beginning on the right lead, complete three circles to the right: the first two circles large and fast; the third circle small and slow. Stop at the center of the arena.
4. Complete four spins to the right. Hesitate.
5. Beginning on the left lead, run a large fast circle to the left, change leads at the center of the arena, run a large fast circle to the right, and change leads at the center of the arena. (Figure 8)
6. Continue around previous circle to the left but do not close this circle. Run up the right side of the arena past the center marker and do a right rollback at least twenty feet (6 meters) from the wall or fence - no hesitation.
7. Continue around previous circle but do not close this circle. Run up the left side of the arena past the center marker and do a left rollback at least twenty feet (6 meters) from the wall or fence - no hesitation.
8. Continue back around previous circle but do not close this circle. Run up the right side of the arena past the center marker and do a sliding stop at least twenty feet (6 meters) from the wall or fence. Back up at least ten feet (3 meters). Hesitate to demonstrate completion of the pattern.

Rider may drop bridle to the designated judge.

BEGINNER'S EQUITATION PATTERNS

In all patterns, where a Jog or Trot is called for, Western Riders should jog and English riders should trot unless specified otherwise.

BEGINNER'S EQUITATION PATTERN #1

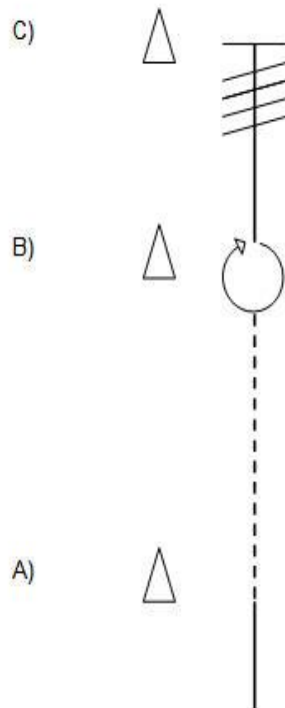

- 1) Walk to Cone A.
- 2) Jog or Trot to Cone B.
- 3) At B, Stop and perform a 360° turn in either direction (western riders turn on the hindquarters, English riders turn on the forehand.)
- 4) Walk to C. Stop and back 5 steps.

BEGINNER'S EQUITATION PATTERN #2

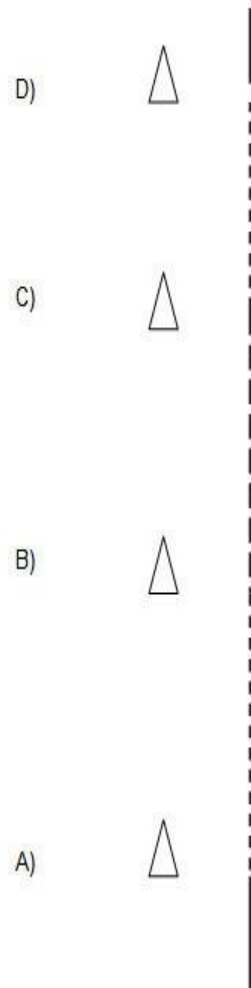

- 1) Walk to Cone A.
- 2) At Cone A begin jog/trot.
- 3) At Cone B, western riders extend the jog, English riders change diagonal and continue to trot.
- 4) At Cone C, western riders return to jog, English riders change diagonal.
- 5) At Cone D, break to walk and walk to lineup.

BEGINNER'S EQUITATION PATTERN #3

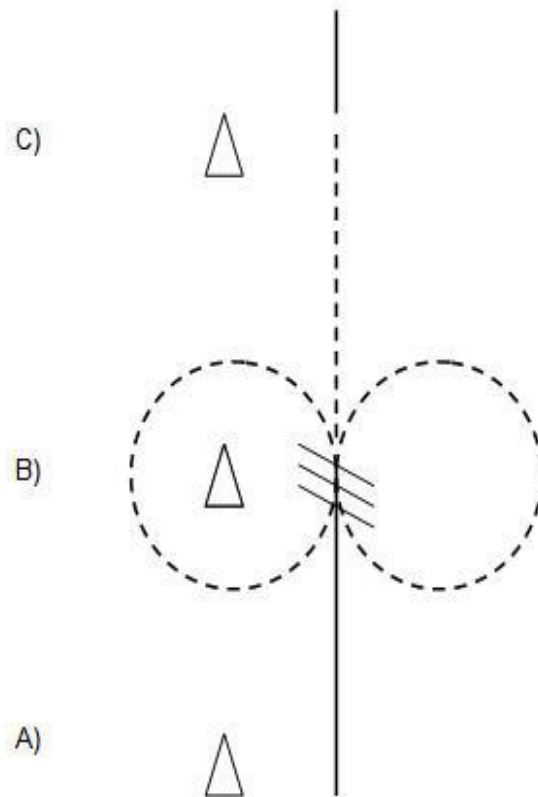

- 1) Walk from Cone A to Cone B. Stop at Cone B.
- 2) Back 3 steps.
- 3) Jog/Trot a figure 8.
- 4) Continue trotting to Cone C.
- 5) Walk and proceed to the lineup.

BEGINNER'S EQUITATION PATTERN #4

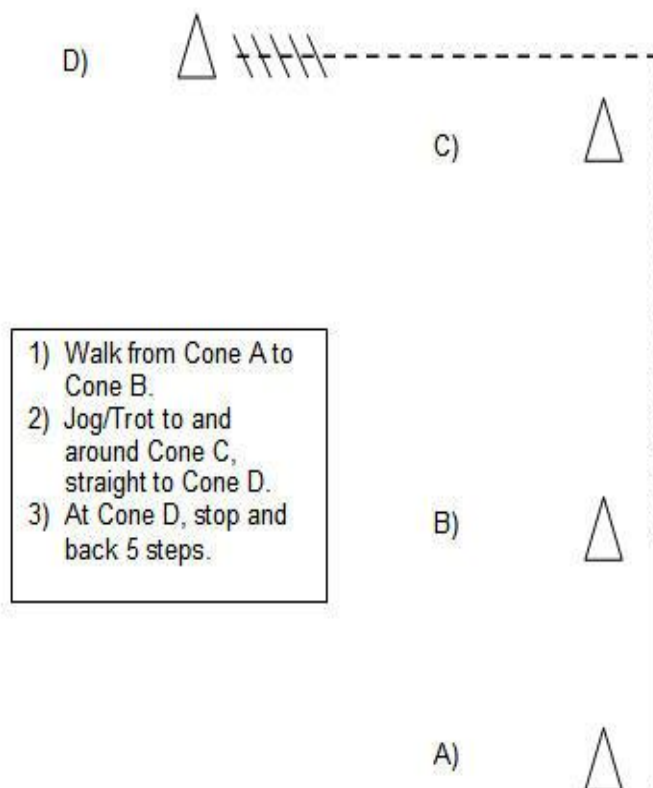

RANCH RIDING PATTERNS

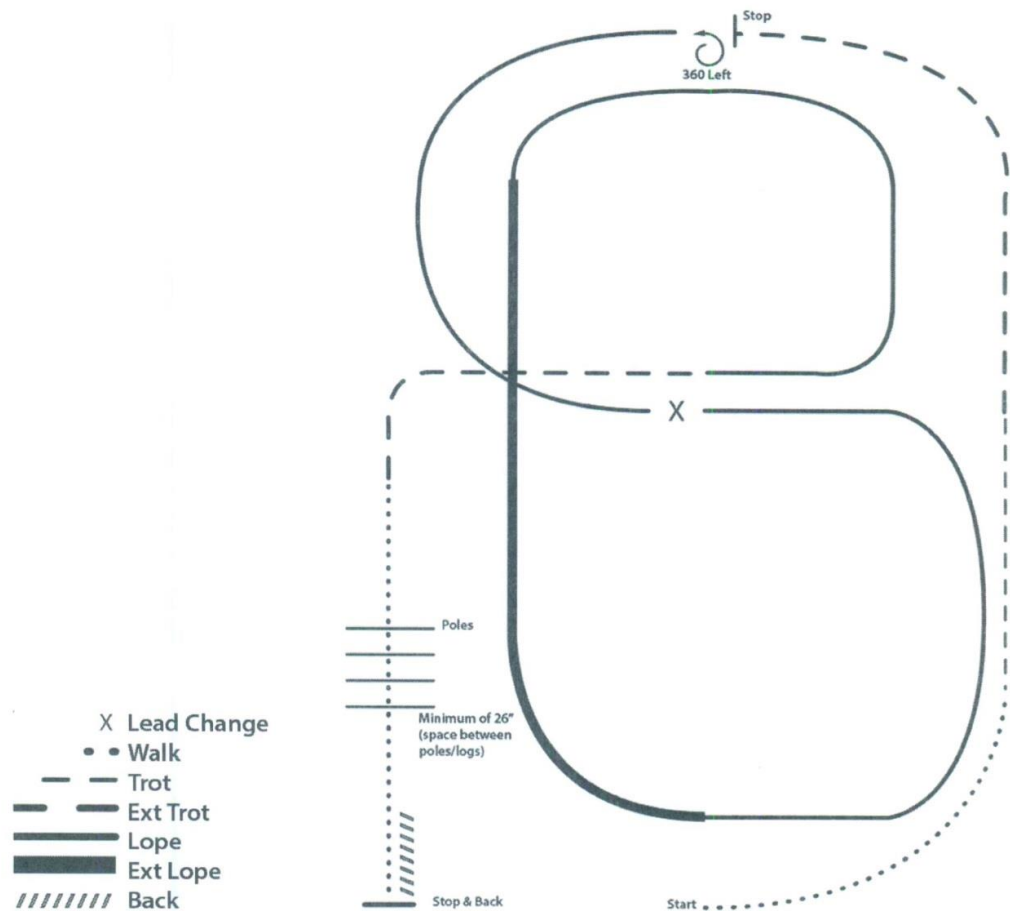

RANCH RIDING – PATTERN I

1. Walk
2. Trot
3. Extend the trot, at the top of the arena ,stop
4. 360 degree turn to the left
5. Left lead 1/2 circle, lope to the center
6. Change leads (simple or flying)
7. Right lead 1/2 circle
8. Extended lope up the long side of the arena (right lead)
9. Collect back to a lope around the top of the arena and back to center
10. Break down to an extended trot
11. Walk over poles
12. Stop and back

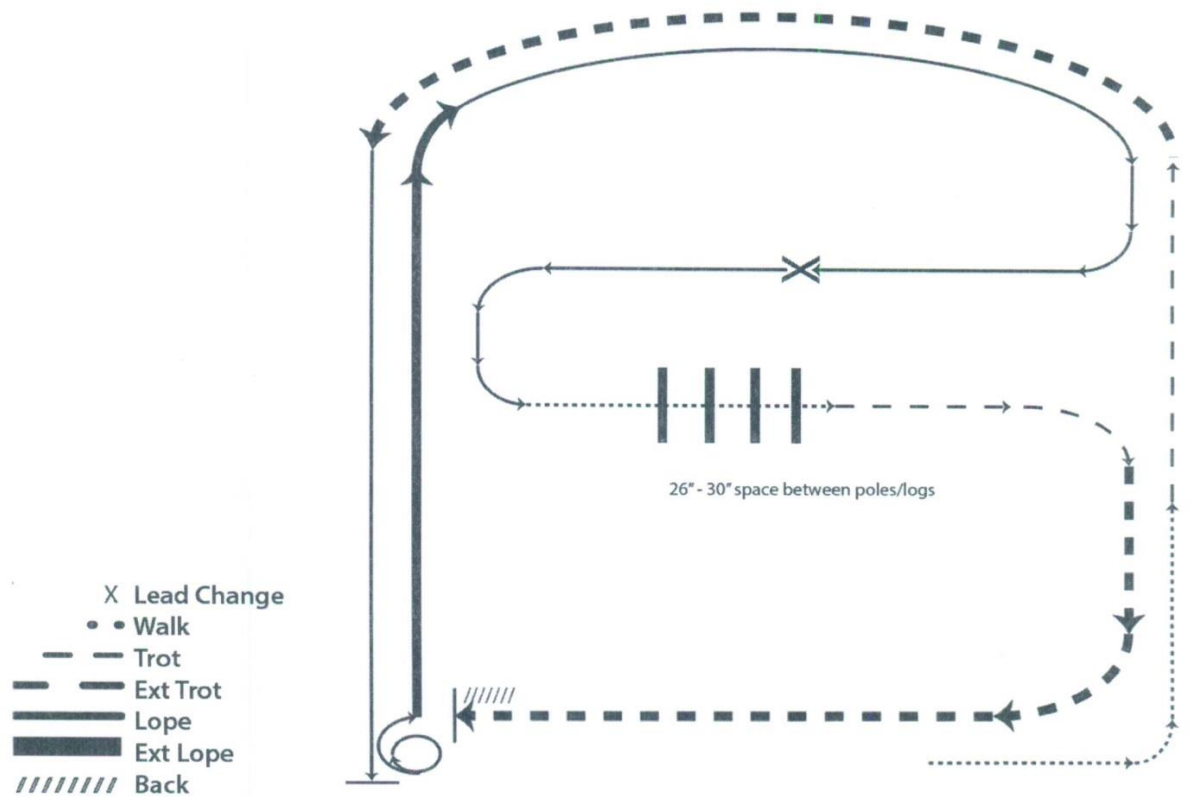

RANCH RIDING – PATTERN 2

1. Walk
2. Trot
3. Extended trot
4. Left lead lope
5. Stop, 1 1/2 turn right
6. Extended lope
7. Collect to working lope-right lead
8. Change leads (simple or flying)
9. Walk
10. Walk over logs
11. Trot
12. Extended trot
13. Stop and back

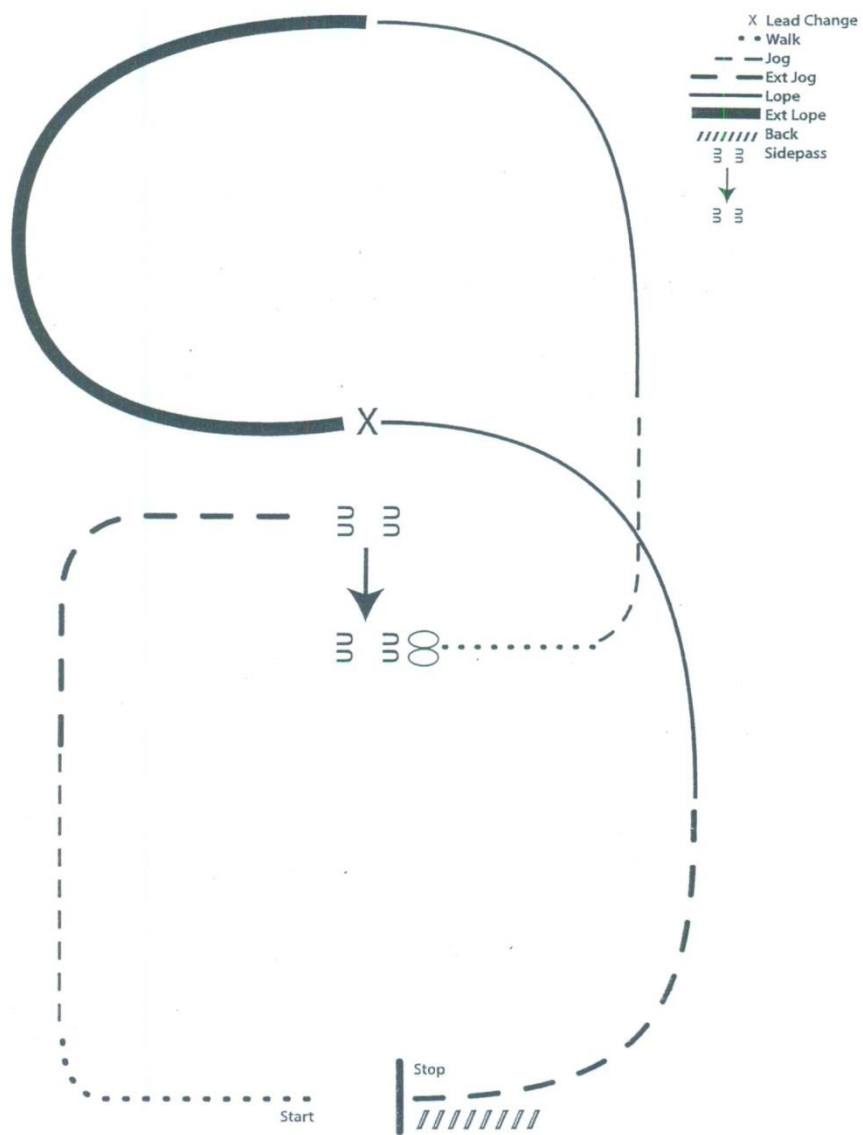

RANCH RIDING -- PATTERN 3

1. Walk to the left around corner of the arena
2. Trot
3. Extend alongside of the arena and around the corner to center
4. Stop, side pass right
5. 360° turn each direction (either way 1st)
6. Walk
7. Trot
8. Lope left lead
9. Extend the lope
10. Change leads (simple or flying)
11. Collect to the lope
12. Extended Trot
13. Stop and back

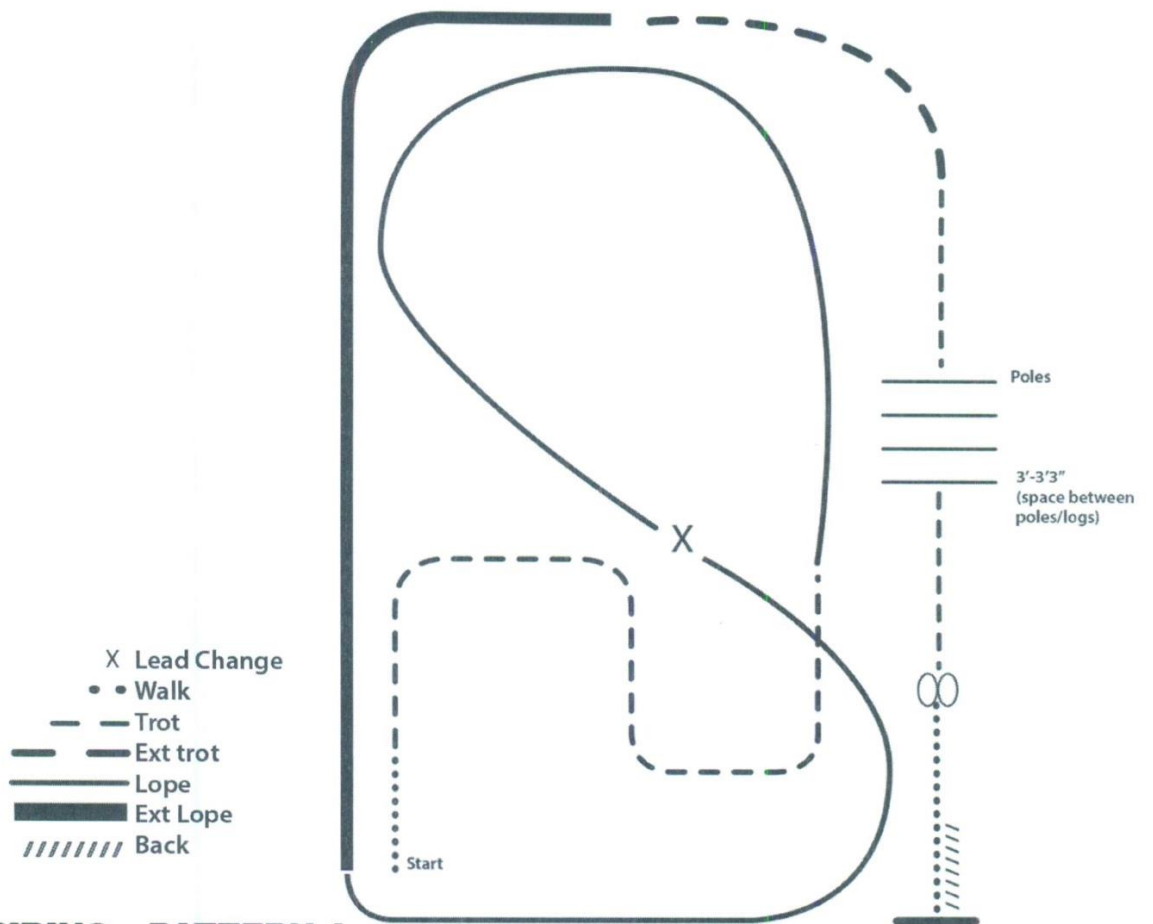

RANCH RIDING - PATTERN 4

1. Walk
2. Trot serpentine
3. Lope left lead around the end of the arena and then diagonally across the arena
4. Change leads (simple or flying) and
5. Lope on the right lead around end of the arena
6. Extend lope on the straight away and around corner to the center of the arena
7. Extend trot around corner of the arena
8. Collect to a trot
9. Trot over poles
10. Stop, do 360 degree turn each direction (either direction 1st) (L-R or R-L)
11. Walk, stop and back

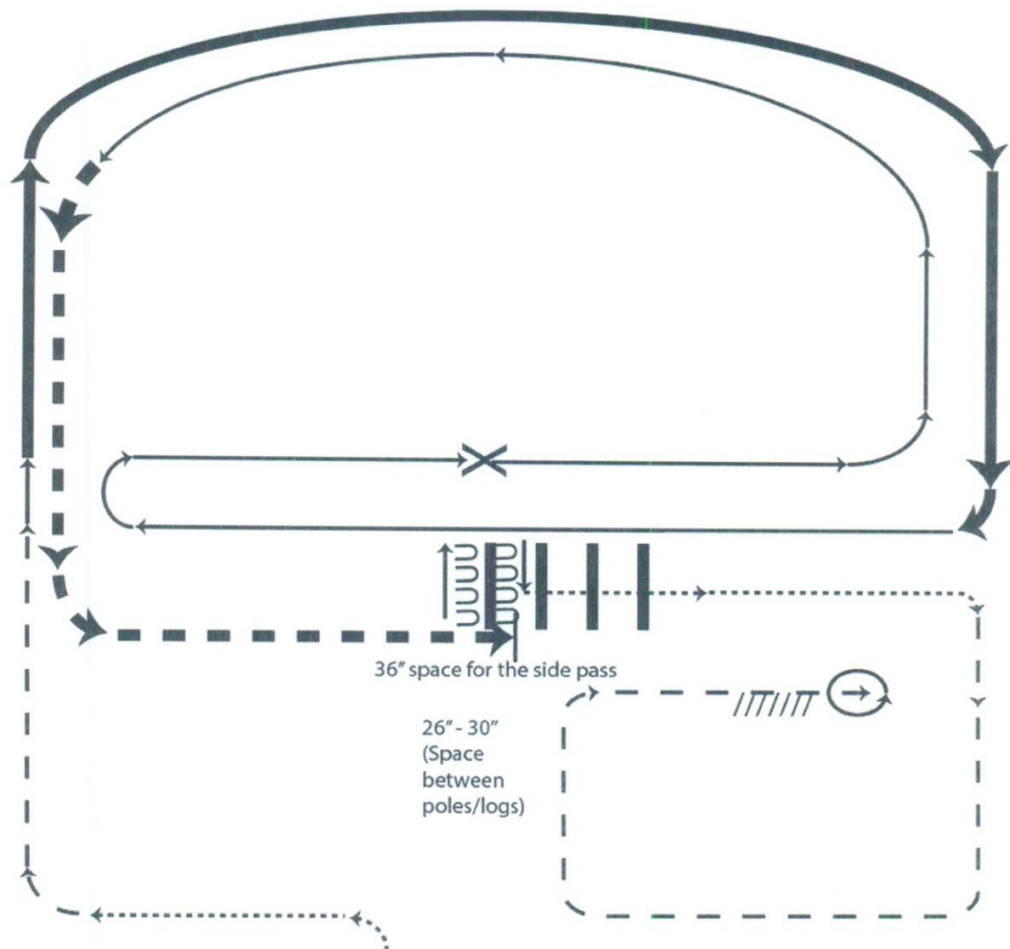

RANCH RIDING – PATTERN 5

1. Walk
2. Trot
3. Extended lope-right lead
4. Lope-right lead
5. Change leads (simple or flying)
6. Lope left lead
7. Extended trot
8. Stop, side pass left, side pass right, 1/2 way
9. Walk over logs
10. Walk
11. Trot square
12. Stop, 360° turn left, back

- X Lead Change
- • Walk
- - Trot
- - Ext Trot
- — Lope
- — Ext Lope
- ////// Back